

# Discovering Through HYDROPONICS



PROJECT PARTNERS



## Project Partners

### National Farm to School Network

The [National Farm to School Network](#) has a vision of a strong and just food system for all, and we seek deep transformation toward this vision through farm to school – the ways kids eat, grow, and learn about food in schools and early care and education (ECE) settings. As the national leader of the farm to school and farm to ECE movement, National Farm to School Network advocates for policy and systems change, facilitates networking opportunities, and offers professional development and resources for food system leaders. Our network includes partner organizations across all 50 states, Washington, D.C., the U.S. Territories and sovereign nations, an advisory board, national staff, and tens of thousands of farm to school and ECE supporters.

### Scotts Miracle-Gro Foundation

The mission of [The Scotts Miracle-Gro Foundation](#) is to inspire, connect, and cultivate a community of purpose. The Foundation is deeply rooted in helping create healthier communities, empower the next generation, and preserve our planet. The Foundation is a 501(c)(3) organization that funds non-profit entities that support its core initiatives in the form of grants, endowments, and multi-year capital gifts.

### KidsGardening.org

[KidsGardening](#) has been helping youth garden programs across the country thrive since 1982. We offer inspiration and support to educators and families by way of grants, original educational resources, and by cultivating a community of practice. Our mission is to create opportunities for kids to play, learn, and grow through gardening, engaging their natural curiosity and wonder.

## Project Team

Jenileigh Harris, Program Associate and Lacy Stephens, Program Manager, National Farm to School Network  
Carol Kauffman, Manager of Corporate Social Responsibility, and Lindsay LaSala, Community and Foundation Relations Manager, The Scotts Miracle-Gro Foundation  
Sarah Pounders, Senior Education Specialist and Emily Shipman, Executive Director, KidsGardening

## Illustrators

Carrie Colalella and Suzanne DeJohn

## Editor

Suzanne DeJohn

## Educational Reviewers

Lori Davis, San Pedro Elementary  
Diego Moreno, Tubman Elementary  
Lynné Steinhaus, Kids Care Elementary

## Graphic Designer

Sylvie Vidrine, Sly Dog Studio

## Spanish Translator

Johanna Roman, GLA Services

**This book incorporates text and ideas from the following KidsGardening/National Gardening Association publication:**

*Exploring Classroom Hydroponics* by Joreen Hendry, Eve Pranis, and Victoria Beliveau.

Copyright © 2021 by KidsGardening.org.

132 Intervale Road, Burlington, VT 05401. [www.kidsgardening.org](http://www.kidsgardening.org).

All rights reserved. No part of this book may be reproduced in any form or by any means without the written permission of the publisher.

ISBN: 978-0-9992234-6-8

# Table of Contents

Lesson 1: Plant Needs .....	7
Lesson 2: Plant Parts.....	34
Lesson 3: Plant Life Cycle.....	51
Lesson 4: Farm (& Garden) to Table.....	67
Lesson 5: Water Versus Soil: A Hydroponic Investigation.....	83
Appendix A: Hydroponic Basics.....	99
Appendix B: Hydroponic Systems Guide .....	106
Appendix C: Steps to Starting a Hydroponic Garden Program .....	110
Appendix D: Using Your Hydroponic Garden Harvest .....	114
Appendix E: Hydroponics for Early Childhood Educators.....	117
Appendix F: Resources .....	119

# Discovering Through Hydroponics

## INTRODUCTION

Plants are an indispensable part of our world. Through photosynthesis, plants have the amazing ability to transform the energy of the sun into the food that they, along with all other living creatures, rely on for survival. They also play a key role in air, water, and soil health and provide shelter for animals of all sizes. Quite simply, if there were no plants, there would be no life on Earth.

In their earliest school years, children are exploring how the world around them works. Learning about plants and their importance in our environment is a central concept for them to grasp. They start with the basics by investigating plant needs, identifying plant parts and their functions, and exploring the path of a plant's life cycle from seed to seed. This early knowledge provides a foundation for respecting plant life in both our wild and cultivated spaces. It is a starting point for understanding how the elements in an ecosystem work together and cultivating empathy for all life.

The garden, especially an edible garden, is a remarkable learning tool to support these early explorations. First and foremost, it helps them gain an appreciation for our food system and the work of our farmers. However, the benefits do not end there. Garden programs can also provide:

**Mental Benefits** – Garden lessons offer real-life, practical applications. For example, instead of calculating the volume of a rectangular prism, they are using the same formula to calculate how much soil they need for a raised bed or water they need for a hydroponic system. Instead of memorizing the life cycle of a plant, they are witnessing each step first hand as seeds they plant transform over time. These types of hands-on learning opportunities have proven to be beneficial for all children, but shown to be especially impactful on students who learn better in non-traditional learning environments. Gardens can be used to engage learners who need more tactile and sensory driven experiences. Practicing mindfulness (e.g., breathing exercises, movement, observation activities) with students promotes use of their five senses to engage with the world around them - a great skill for not only observing plants but also managing stress and anxiety.

**Physical Benefits** – Edible gardens can increase access to fresh fruits and vegetables. Even though harvest may or may not be large enough to make a significant impact on local food availability, it provides motivation for young children to try new fruits and vegetables and may lead to changes in nutritional attitudes and adoption of healthier eating behaviors. Gardens also offer opportunities for physical activity and time in nature.

**Social Benefits** – Gardeners learn to work in teams and are able to connect with peers through the positive, shared experience of caring for their garden. Gardens provide purpose and a sense of belonging to something bigger than themselves. Other social benefits include patience, empathy, and cooperation, all of which are critical yet often overlooked prerequisites for academic success. Additionally, school garden programs can be used as models and offer training opportunities for establishing new, locally based food systems and as such can serve as a vehicle for promoting social equity in communities.

**Emotional Benefits** – Gardening has been shown to decrease feelings of stress and anxiety. Observing the calming cycles and rhythms in nature can bring a sense of well being into the often loud and chaotic human world. Learning how to grow your own food is an empowering lesson that contributes to feelings of confidence, independence and security that few other learning experiences can provide. Students learn how to care for other living things and can transfer that knowledge into learning how to care for themselves. Additionally, gardening has been shown to be an effective trauma-informed approach to support students with Adverse Childhood and/or Community Experiences and to create safe and positive learning environments.

The options for incorporating gardening into classrooms and other educational settings are as numerous as the many benefits they provide. Most early elementary plant lessons for young children focus on how plants grow in nature and/or traditional agriculture systems where soil provides support and fulfills plants' need for nutrients and water. But do plants need soil to grow and thrive? The answer is no. Is this a fact that may have significant meaning for people? Yes!

Hydroponics, in its simplest form, is growing plants by supplying necessary nutrients in the plants' water supply rather than through the soil. The word derives from the Greek root words "hydro," meaning water, and "ponics," meaning working. Although often considered new technology, people living in areas where environmental conditions or community infrastructure posed challenges to traditional growing methods have used hydroponic techniques to grow plants for food and beauty for hundreds, maybe thousands, of years. Presently, designing hydroponic growing systems is at the forefront of agricultural technology and innovation. Scientists and farmers are looking for new ways to grow food crops efficiently for large populations who are oftentimes living in parts of the world where space, good soil, and/or water are limited. As people deepen their appreciation for and their understanding of the environmental and societal benefits of growing and consuming local food, scientists and farmers are exploring all growing techniques to help local, affordable fresh food availability match need and demand.

Cultivating and observing plants in hydroponic systems with young children (rather than exclusively through more traditional soil-based methods) allows them to understand plant needs at a deeper level. They discover the amazing skill of our green friends to adapt to different growing conditions. Their curiosity is sparked as they are challenged to design growing systems that seek to use resources efficiently and provide locally grown food even when existing environmental conditions do not support traditional growing methods. They are engaged in science, technology, engineering, and math through the practical lens of fulfilling the essential job of growing food. As an added bonus, edible hydroponic gardens offer opportunities for students to experience the joy and excitement of sampling the fruits of their labor!

The following guide is designed to facilitate teaching plant basics to young students using the engaging, hands-on tool of a hydroponic garden. In doing so, there is no value being assigned to imply one type of growing method (hydroponic vs. soil-based) is ultimately better than the other but rather the lessons hope to engage students in the process of evaluating the pros and cons of different growing systems and the importance of thinking outside the box when looking to secure a sustainable food system. The goal is to convey that the mission to find ways to grow food most efficiently in terms of natural resources and space available — while also providing access to bountiful, healthy fresh foods to all people, regardless of where they live — is absolutely critical for our society.

Hydroponic growing systems are actively being explored as a solution for growing fresh fruits and vegetables in densely populated urban areas, in water insecure deserts, and even as a way to help increase home food production. Could this innovative growing technique help bring the nutritional benefits of fresh fruit and vegetables to more people? Could it increase the supply of affordable, local foods? Could it help us create a more equitable food system? Perhaps these lessons will inspire the creativity and ingenuity of our next generation of food producers who will need to find answers to both questions — your students!

## How to use this Guide

This guide includes:

- 5 lesson plans to help students learn plant basics through hands-on, garden-related investigations;
- basic how-to information for growing plants hydroponically
- construction plans for simple DIY hydroponics setups; and
- additional reference materials to support your hydroponic garden program creation and endeavors.

The lessons in this guide are listed in a sequenced order with the content building from one lesson to the next; therefore, it is best to deliver the lessons in the order in which they are presented. Each lesson plan includes:

- **Guiding Questions:** These are the big picture questions that the lessons are designed to help students explore.
- **Materials:** A list of all the materials needed to complete the activities.
- **Time:** An estimate of the amount of time each lesson should take.
- **Lesson Summary:** A brief summary of the lesson for quick reference.
- **Learning Outcomes:** A list of what students should know upon completion of the activities in the lesson.
- **Background Information:** Supplemental information the educator may need to help guide students through the lesson plan.
- **Laying the Groundwork:** An introductory activity to inspire students to begin critically thinking about the topic.
- **Exploration:** An activity designed to engage students in hands-on investigations to help them explore the topic through firsthand examples.
- **Making Connections:** A wrap-up activity to encourage students to apply their investigation results and new knowledge to their daily life.
- **Extension:** Optional ideas for continuing student learning about the topic in more depth.

The lessons are designed to provide real world and practical experiences while also encouraging student-led discovery, through hands-on and inquiry-driven exploration opportunities. Through modeling, students will gain a foundation of knowledge to help them develop their own questions, deepen their understanding, and begin to contemplate solutions to the present-day challenges of our food system.

Although not a Next Generation Science Standard (NGSS) curriculum, the concepts presented and activities suggested in *Discovering Through Hydroponics* are designed to help inspire educators working within the NGSS framework. Some of the Next Generation Science Standard Performance Expectations considered during the development of this guide include:

## Kindergarten

Use a model to represent the relationship between the needs of different plants and animals (including humans) and the places they live. [K-ESS3-1](#)

Communicate solutions that will reduce the impact of humans on the land, water, air, and/or other living things in the local environment. [K-ESS3-3](#)

Use observations to describe patterns of what plants and animals (including humans) need to survive. [K-LS1-1](#)

### First Grade

Use materials to design a solution to a human problem by mimicking how plants and/or animals use their external parts to help them survive, grow, and meet their needs. [1-LS1-1](#)

### Second Grade

Plan and conduct an investigation to determine if plants need sunlight and water to grow. [2-LS2-1](#)

Recognizing that the teaching objectives of the educators using this guide will vary greatly, the lessons provide inspiration and guidance, but allow for the flexibility to be adapted to meet many different teaching styles, curriculum standards and educational settings. The target audience for the guide is grades kindergarten through second grade; however, the lessons also include suggestions for adapting the activities for younger and older students. We encourage you to use these lessons as a starting point for inspiration and support, and adapt as needed for your students, standards, and learning environment.

If you would like additional lesson ideas for students in third through fifth grade, a companion classroom guide titled *Exploring Hydroponics* is available to download online at: <http://www.farmtoschool.org/resources-main/exploring-hydroponics-a-classroom-lesson-guide>.

Happy Hydroponic Gardening!



## **LESSON 1**

### **Plant Needs**

---

#### **Guiding Questions:**

- What do plants need to live and grow?
- What resources are available to help plants meet their needs?

## **LESSON 2**

### **Plant Parts**

---

#### **Guiding Questions:**

- What are the basic parts of a plant?
- What is the function of each plant part?

## **LESSON 3**

### **Plant Life Cycle**

---

#### **Guiding Questions:**

- What are the stages of a plant's life cycle?
- How do plant needs and plant parts change in each stage of a plant's life cycle?

## **LESSON 4**

### **Farm (& Garden) to Table**

---

#### **Guiding Questions:**

- Why are plants important to people?
- Where does our food come from?
- Who is involved along the path that our food travels from field to table?

## **LESSON 5**

### **Farms of the Future**

---

#### **Guiding Questions:**

- What are some of the challenges facing farmers today?
- How might hydroponic growing methods help support our food system?

# LESSON 1

## Plant Needs

### Guiding Questions

What do plants need to live and grow?  
What resources are available to help plants meet their needs?

### Materials

#### Laying the Groundwork:

- Marker or dry erase marker
- Chart paper or dry erase board
- Plant Needs Cards, available at end of lesson (optional)

#### Exploration:

- Clear plastic cups (9 oz. party cups work well; however, other sizes are also fine)
- Potting soil
- Paper towels
- Dried bean seeds
- Construction Paper

#### Making Connections:

- “My Plant Needs...” Activity Booklet, available at end of lesson

#### Extension (Optional):

- Internet access for videos
- Pots and potting soil for container gardens
- Prefabricated or DIY hydroponic units (Instructions for some easy DIY units available at end of lesson and in the appendix.)
- Hydroponic solution
- Lettuce or basil seeds

### Time

**Laying the Groundwork:** 30 minutes

**Exploration:** 7 to 10 days

**Making Connections:** 30 minutes

**Extension:** 6 to 8 weeks

### Lesson Summary

Plants must secure the basic needs of water, light, air, nutrients, and a place to grow to live and thrive. Their needs can be met through traditional soil-based growing methods and also through alternative growing systems like hydroponics.

### Learning Outcomes

After completing this lesson, students will:

- Be able to list the five needs of plants: light, air, water, nutrients, and space to grow.
- Understand that plants’ needs can be met in different ways, allowing them to grow in many different environments.
- Discover that hydroponic systems are designed to fulfill all five plant needs.

## Background Information

Plants, like all living things, have certain requirements that need to be met for them to grow and thrive. These include water, nutrients, light, air, and a place to grow. Here is a description of why each of these components is important to a plant:

### Water

Water is required for photosynthesis (production of food) and transpiration (evaporation of water from leaves into the air, cooling the plant and creating pressure to move water from roots to leaves). It also aids in the absorption of some nutrients.

### Air

Plants respire by taking in oxygen, which triggers plant cells to release and use the energy manufactured during photosynthesis, while also releasing carbon dioxide and water. Although we mostly think of plant leaves taking part in this air exchange, plant roots are also part of this process and typically take in oxygen that is available in the small spaces in between soil particles.

### Light

Plants capture light energy for use in photosynthesis — the process by which plants make their food.

### Nutrients

Plants require certain minerals for proper growth and function of biological processes. In nature, plants obtain most of their needed nutrients from the soil. Nutrients occur naturally in the soil as a byproduct of decomposition of organic matter or derived from parent rock, or can be added through fertilizer\* applications. These nutrients or minerals are not actual food, but rather are elements vital to helping the plant utilize the sugars (the real food) that it produces during photosynthesis.

\*Fertilizer is sometimes referred to as “plant food,” but plants actually make their own food through the process of photosynthesis. Fertilizer is more accurately compared to a multivitamin.

### A Place to Grow

Plants need a place to call their own. They need a way to anchor their roots so that their top growth is secure against environmental conditions such as wind, the leaves can expand to capture light, and the plant has the ability to reach its full growth potential.

## Meeting Plant Needs in Hydroponic Growing Systems

In traditional gardening, plants get root support, nutrients, water, and oxygen from the soil. In hydroponic systems, people provide plants' needs in a water-based environment. Adaptations of hydroponic growing techniques to fulfill these critical plant needs include:

### Water

Distilled water between 65 and 75 degrees Fahrenheit is preferred for hydroponics systems because it optimizes the availability of the dissolved nutrients in the solution. Tap water may contain significant concentrations of chlorine, which can adversely affect plant growth. If your water has a lot of chlorine, you can purchase distilled water or simply let a container of tap water stand uncovered for a couple of days before using it to allow the chlorine to dissipate.

### Air

Both the top growth and roots of hydroponic plants need access to air. Just like traditionally grown plants, air is usually readily available to the top growth of hydroponic plants. When grown indoors, or in tightly packed conditions, it can be helpful to have a fan circulate the air around the plants. The air movement contributes to stem strength and prevents excess moisture on plant leaves.

However, plants growing in water need human intervention to provide the air needed for their root growth. In healthy soil there are naturally occurring pockets of air and water, both of which contribute to proper root growth and functioning. It is important for students to understand that roots must also have oxygen for the plant to survive, so hydroponic systems cannot merely submerge the roots in a bath of water for a plant to function properly and survive long-term.

There are many different ways for hydroponic systems to deliver this mix of water and oxygen to the roots. In some setups, water and nutrients reach the roots via a wick made of absorbent material, and part of the roots are continually exposed to air. Others actually grow the plants in a porous medium like rockwool (defined below), which acts as a soil substitute due to its capacity to offer similar pockets of air and water for roots. Some hydroponic systems use a pump to infuse oxygen into the water, similar to how a fish tank aquarium works. Another option is for the medium and roots to be periodically splashed or flooded with a nutrient solution, allowing oxygen to bathe the roots in the interim.

### A Place to Grow/ Root Support

The material that a plant lives in or on is called its medium or substrate. For most plants, the medium is soil. As stated above, soil naturally provides pockets of both water and air and provides plant roots with the structure necessary so the plant can anchor itself securely.

Hydroponic growers find other ways to support growth — and to prevent drowning roots by allowing them to remain sitting in water. Many setups use an inert, sterile medium to serve as a base (in effect, a soil substitute). Some of the more popular choices include:

- gravel
- clean sand
- perlite (volcanic material that is heated until it expands into a lightweight, styrofoam-like material)
- a lightweight pebble-like aggregate
- rockwool (an inorganic substance made from molten rock that has been spun into fibers and then compressed into spongy blocks and air).

These materials provide passages among the particles or fibers where air and water can circulate.

Each medium has strengths and weaknesses. Gravel and sand, for instance, provide support and good drainage, but can be heavy when wet and will dry out fast. Perlite is light and holds water well, but its fine dust can irritate lungs. (Sprinkle it lightly with water to avoid this.) Rockwool holds water and air nicely and makes it easy to move plants around, but breaks down fairly quickly.

Other hydroponics systems have no real support media, but rather incorporate more or less elaborate ways of suspending plants in nutrient solutions. In the commercial nutrient film technique (NFT) and aeroponics, for instance, the roots lie or are suspended in a dark channel and nutrients are sprayed or trickled along the root zone.

## Light

All green plants require light to drive the process of photosynthesis. The higher the light level, the potentially larger your hydroponic harvest, as long as you're adequately meeting other basic needs (only up to a certain point, because too much light can be as detrimental as not enough). If your plants are getting leggy, which means they are growing quickly and producing skinny stems and sparse leaf growth, or not growing at all, the light source is the first factor to check. Keep a close eye on how your plants are responding to light and adjust exposure accordingly. Hydroponic systems can be designed to provide light from numerous sources.

**Natural Light:** The sun radiates the full spectrum of light essential to plant life. A greenhouse allows sunlight to reach plants and is a great location for growing hydroponically. A sunny windowsill will suffice for many non-fruiting vegetables and

lower light herbs as long as you place your hydroponic unit just 1 or 2 feet away from the glass. Keep in mind that natural sunlight outdoors or in a windowsill will be available in greater quantities and intensity during late spring to early fall months. In climates with a lot of sunlight and high temperatures, your plants may need to be shaded during the brightest parts of the day, especially when grown outdoors.

**Artificial Light:** Fluorescent or LED light bulbs can also be used to deliver needed light to indoor hydroponic crops. These lights will typically be hung from the ceiling or from a structure specifically built for the plants and kept on 14 to 16 hours per day.

## Nutrients

In soil, nutrients come from rock and mineral leaching and organic matter decomposition. They are “held” by the soil particles and dissolved in the surrounding water before being absorbed by the roots. In hydroponics, growers add nutrients to the irrigation water being applied to the roots.

The easiest way to supply these nutrients is to purchase prepared/formulated hydroponic nutrients in dried or liquid form. Most hydroponic formulas are concentrated and must be mixed with water. Alternatively, individual nutrients can also be purchased to make your own nutrient solution. When working with nutrients, it is important to follow all recommendations of the manufacturer. Additional information about nutrients for hydroponic systems can be found in *Appendix A: Hydroponic Basics*.

## Laying the Groundwork

Begin by asking your students, “What do we need to live? What are our basic needs?” From insects to elephants, all animals (including people) have similar things we need in order to live.

Next, switch their focus to plants and ask, “What about plants? Are they alive? Do you think they need things to grow and live too? What do plants need?”

Create a student-generated class list on chart paper or a dry erase board listing the things they think plants need to grow and to stay healthy. If you would like your exploration to be completely student driven, stop here and move on to the Exploration activity below and guide them to create investigations to determine if their list is accurate.

If you think your students need additional definition before the Exploration, work together to fine-tune their list of plant needs until you create a solid list including water, air, light, nutrients, and a place to grow. Continue their brainstorming by asking “How do plants obtain these needs? Are there different resources available to them to

meet their needs?” You can then use the Plant Needs Cards available at the end of this lesson to play a sorting game to fill in a Plant Needs Chart.

Plant Needs Chart Activity: Draw one Plants Needs Card from the stack and then as a class, decide which need it fills and tape the card underneath or to the side of your list. For example, if you draw the card with the watering can on it, you would place it under “water.” Here is what your chart may look like:

Water	Air	Light	Nutrients	Place to Grow
Watering can	Wind gust	Sun	Soil	A windowsill container
Hose	Fan	Light bulb	Compost tea	A raised garden bed
Rain drop	Hydroponic/ aquarium air pump	Grow lights	Slow release fertilizer	A hydroponic unit

Once your chart is done ask, “Which of these things do plants get from nature? Which of these things do plants get from people? Does the plant care if the need is fulfilled by nature or people?”

## Exploration

① Charge your students with devising experiments to test the list of plant needs you developed in the Laying the Groundwork Activity. Ask students, “How can we test whether plants need all these items we have listed?” Encourage them to think about prior experiences and observations related to the phenomena of germination and young plant growth. “Have you ever seen plants growing at school, at your house, or in a garden or park? How do they usually grow? Are they usually growing in soil? Do you think plants have to have soil to grow?”

Take a class vote and see how many of the kids think plants need soil and how many kids think they do not need soil. Depending on the math skills you are currently working on, you can compile the results of your vote in tally form, in a graph, or as fractions or percentages. Based on your vote, create a hypothesis or prediction:

“Our class thinks plants need soil to grow” or “Our class thinks plants do not need soil to grow.”

2 Next, share that you want to test your prediction/hypothesis. You can break your class into groups and ask them to brainstorm ways to test whether plants need soil to grow. After having a chance to think about possible experimental designs, you can then give them full control over their investigation, including materials to use, or you can provide additional guidance. Guidance can range from presenting them with the supplies listed in the Materials section above (including bean seeds) and then letting them take it from there or you can also provide more specific instruction. Here is a possible experimental design:

In order to test if plants need soil, we will create an experiment that investigates germinating and growing bean seeds with and without soil. To do this, we will make two types of “seed viewers” — one type with soil, and one type without.

## Make your seed viewers

### Soil Seed Viewers

- Punch a few small holes in the bottom of a clear plastic cup.
- Fill the cup with moist potting soil, leaving about ½ inch from the top so you can water as needed.
- Place 3 to 4 bean seeds along the edge of the cup so that you will be able to see the seeds germinate and begin to grow.
- Keep soil moist.

### Soil-less Seed Viewers

- Cut a piece of construction paper into a rectangular strip to fit inside the plastic cups. This is optional, but it helps with viewing.
- Ball up a few pieces of paper towels and place them inside the construction paper liner until the cup is full.
- Place 3 to 4 beans in the cup between the side of the cup and the paper towels or construction paper liner so the seeds are visible from the outside of the cup.
- Gently water the paper towels in the center until saturated.

If space and resources are available, start one soil seed viewer and one soil-less seed viewer for each student.

3 Place the cups in a warm spot on a shelf or windowsill and have students observe them daily and watch them grow. First you will notice the seed coat expanding (wrinkling) as the seed absorbs water. The roots should start to grow in 2 to 3 days depending on the temperature. Water as necessary to keep the paper towel and soil continually moist.



4 After 7 to 10 days, take time to compare the two seed viewers. Review the chart you made in the Laying the Groundwork about plant needs and see if you provided all of the things plants needed for both types of seed viewers. Did your plants need soil to grow? Was your class prediction/hypothesis correct?

There are many additional ways to test your hypothesis and you can allow students more control over the experimental design if this is a better fit for your students and teaching objectives.

## Making Connections

Have students read through and complete their own “My Plant Needs...” Activity Booklet at the end of this lesson. On each page, ask them to draw a picture of how they can provide the listed need for their plant. Older students can also add in a written description of how they could fulfill their plant’s needs. They can use the Plant Needs Chart you made in the Laying the Groundwork activity as a reference. They can take their activity booklet home, along with the seedlings planted in the Exploration, to share with family and friends.

## Extension (Optional)

Now that students have been introduced to the idea that plant needs can be met in many different ways, it is time to introduce why we might need or want to grow plants using different types of techniques. Inspire their thoughts with questions such as:

- *Why is it important for people to be able to grow and take care of plants?*  
We need plants for food, and for our environment.
- *Can you think of some places in our world where it is hard to grow plants?*  
Big cities, deserts, in the winter, Antarctica, etc.

Share one or more of the following videos of people growing plants hydroponically in Antarctica:

**Exploratorium Subzero Water Works in McMurdo Station on Ross Island, Antarctica:**  
<https://www.exploratorium.edu/video/subzero-water-works>

**Exploratorium Polar Paradise:**  
<https://www.exploratorium.edu/video/polar-paradise?autoplay=true>

**Australian Antarctic Division: Hydroponics:**  
<http://www.antarctica.gov.au/living-and-working/station-life-and-activities/food/hydroponics>

## Science and More: Scientists in Antarctica have harvested the first crop of vegetables grown without soil or light:

<https://www.youtube.com/watch?v=MSJF5t0xX6Y>

Ask, “Could the people of Antarctica grow plants using traditional gardening or farming methods? What kind of benefits did the hydroponically grown plants offer for the people in Antarctica? Why is this important?”

Begin a more in-depth exploration into hydroponic gardening by starting plants using traditional growing methods and a hydroponic system (using either a DIY or a prefabricated hydroponic unit). Lettuce and basil seeds are both really easy to grow and a good place to start if you are a beginning gardener. You can try other types of plants, but the key is to make sure to plant the same thing in both types of systems. For best results, also start multiple samples representing each type of growing system. These plants can be used throughout the lessons in this guide.

**Soil-based plants** can be planted in containers (grown indoor or outdoors), in a raised bed, or directly in the ground. If you need additional instruction on planting seeds, check out Indoor Seed Starting Q&A: <https://kidsgardening.org/gardening-basics-indoor-seed-starting-qa/> and Transplanting and Direct Seeding: <https://kidsgardening.org/gardening-basics-transplanting-and-direct-seeding/>.

**Hydroponic plants** can be grown in a prefabricated hydroponic system (there are many different brands available) or you can make your own. Detailed instructions for some easy DIY hydroponic systems can be found at the end of the lesson. There are instructions for additional DIY hydroponic systems in Appendix B that use a wide range of materials you may have on hand or be able to get donated. Additional information about starting seeds for hydroponic systems can be found at: <https://kidsgardening.org/garden-how-to-starting-seeds-for-hydroponics/>.

After planting and observing growth, talk about how you will meet plant needs in each type of growing system. You can use the chart on the next page to talk about the different ways each system fulfills the plants’ needs:

Need	Plants Grown in Soil	Plants Grown Hydroponically
Water	Water is applied to the soil by nature (rain) or humans (irrigation) and then roots absorb the water from the soil	Water is supplied by humans and roots are either submerged in water continuously or periodically splashed with water
Light	Sunlight or artificial light (usually through sunlight)	Sunlight or artificial light (usually through artificial light)
Air	The soil contains pockets of air for the roots	If submerged in water, air is provided by air pumps; if splashed with water, air is continuously available
Nutrients	Organic matter decomposes and rocks break down, releasing nutrients into the pockets of water in the soil; as the roots take in the water, they also take in the nutrients.	Nutrients needed by plants are added directly to water in the form they can be used and immediately available
A Place to Grow	The soil provides a place for roots to anchor the plants	Humans must provide a substance such as rockwool, gravel or a plastic basket to provide support for plant roots

As your plants grow, track growth using classroom garden journals or using the Soil vs. Hydroponics Data Collection Worksheet available at the end of this lesson.

**Plant Needs Cards**  
**Tarjetas de Necesidades de las Plantas**

**Water can**  
**Regadera**

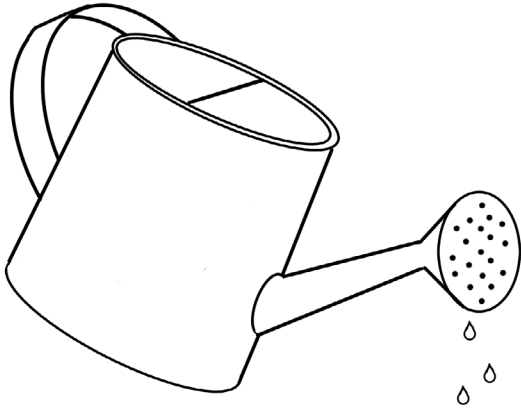

**Watering hose**  
**Manguera de riego**

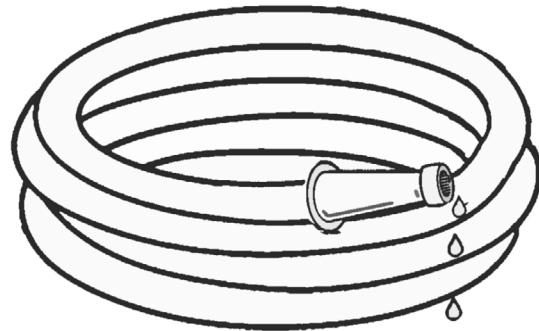

**Rain drop**  
**Gota de lluvia**

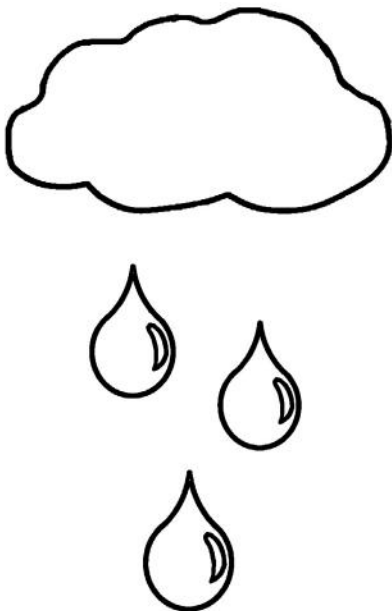

**Wind gust**  
**Ráfaga de viento**

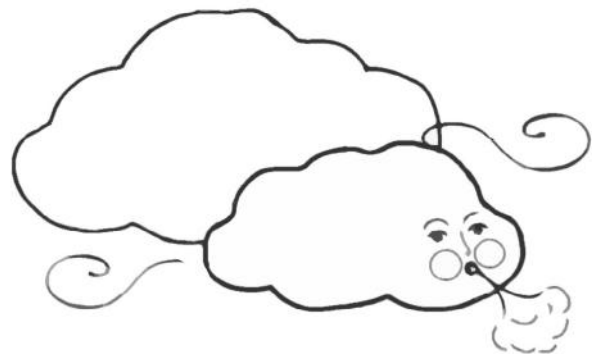

**Plant Needs Cards**  
**Tarjetas de Necesidades de las Plantas**

**Fan**  
**Ventilador**

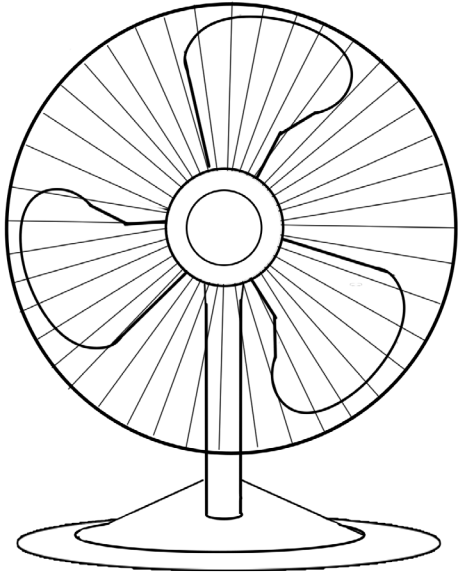

**Hydroponic/Aquarium air pump**  
**Bomba de aire para hidroponía / acuario**

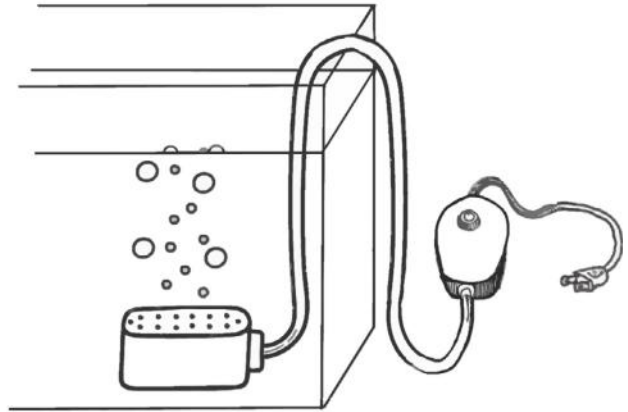

**Sun**  
**Sol**

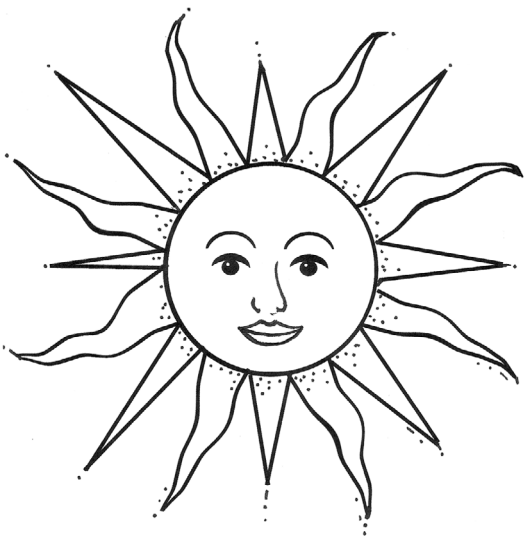

**Light bulb**  
**Bombilla**

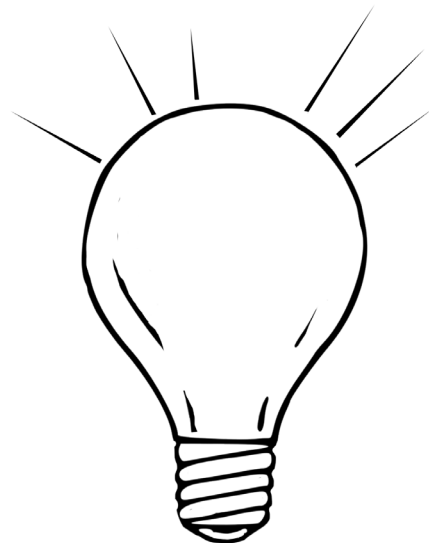

**Plant Needs Cards**  
**Tarjetas de Necesidades de las Plantas**

**Grow lights**  
**Luces de cultivo**

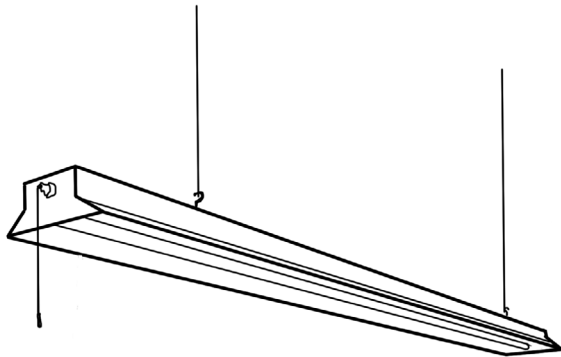

**Soil**  
**Tierra**



**Compost tea**  
**Té de abono**

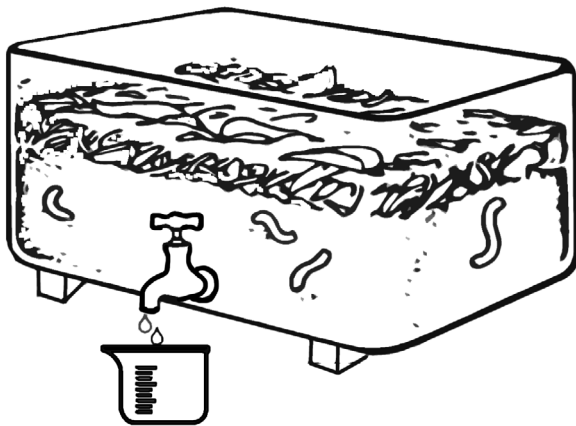

**Slow release fertilizer**  
**Fertilizante de liberación lenta**



**Plant Needs Cards**  
**Tarjetas de Necesidades de las Plantas**

**Windowsill container**  
**Contenedor para alféizar de ventana**

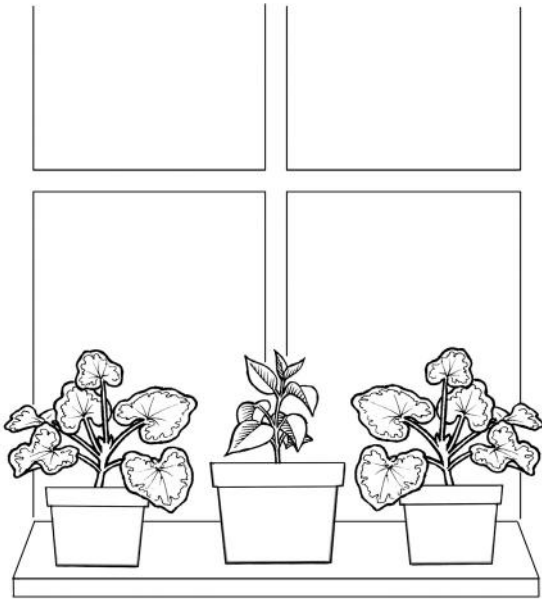

**Raised bed garden**  
**Huerta en bancal elevado**

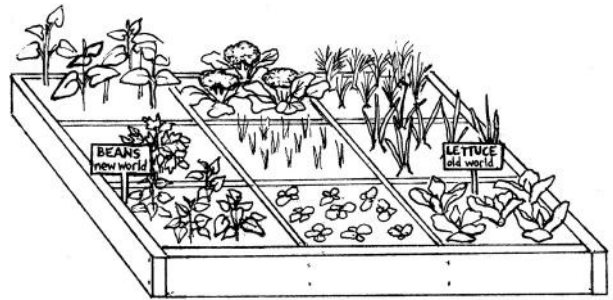

**Hydroponic garden**  
**Huerta hidropónica**

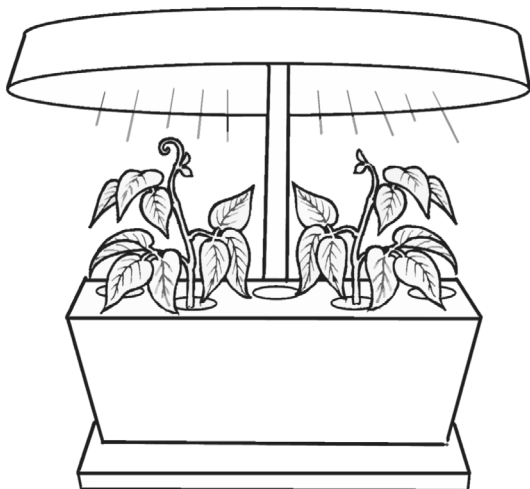

# My Plant Needs...

Activity Booklet

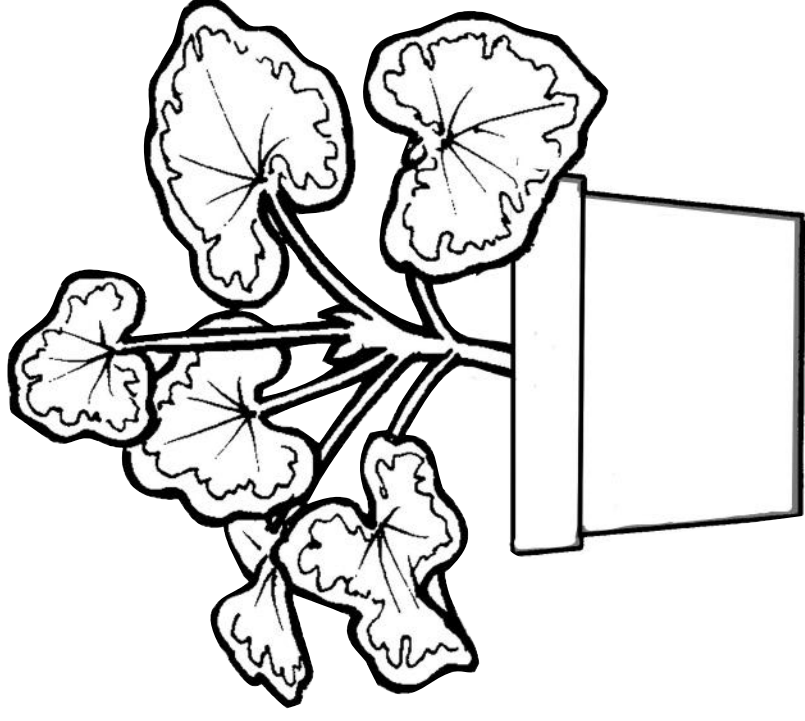



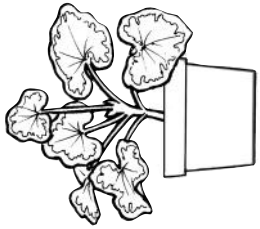

# My Plant Needs...

By \_\_\_\_\_

# My Plant Needs...

A Place to Grow

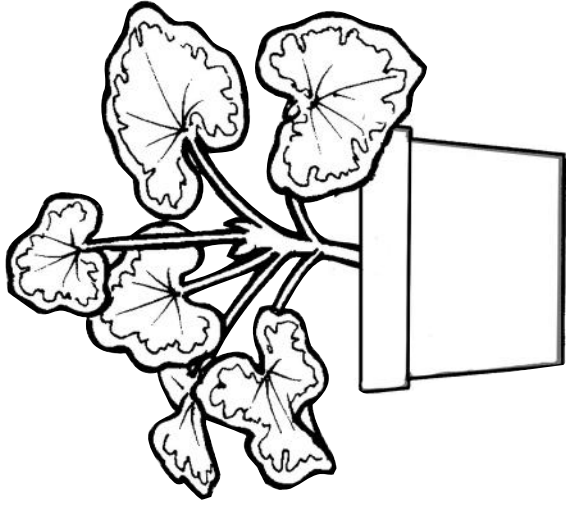

My plant needs a place to grow where it has room for its roots, stems and leaves.  
*(Draw a picture of your plant in its place to grow.)*

## My Plant Needs...

Nutrients

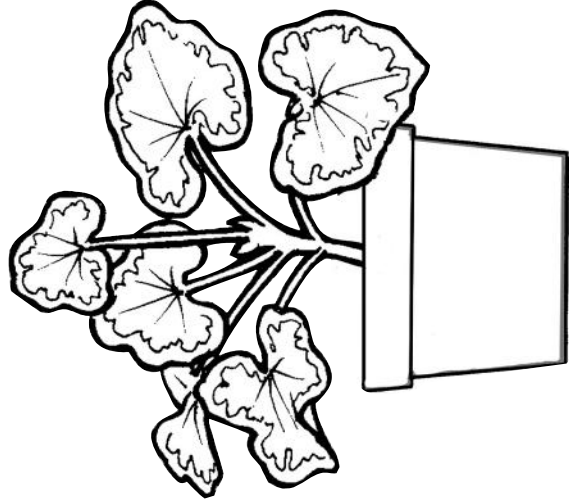

My plant needs nutrients to stay alive and grow bigger.  
*(Draw a picture of your plant getting nutrients.)*

## My Plant Needs...

Water

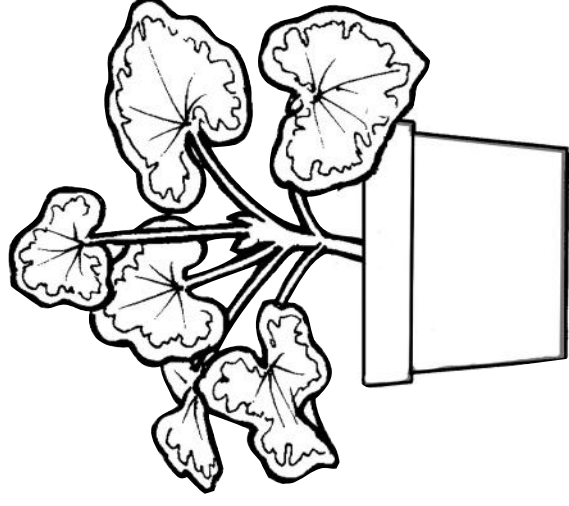

My plant needs water to make food and stay cool.  
*(Draw a picture of your plant getting water.)*

## My Plant Needs...

Light

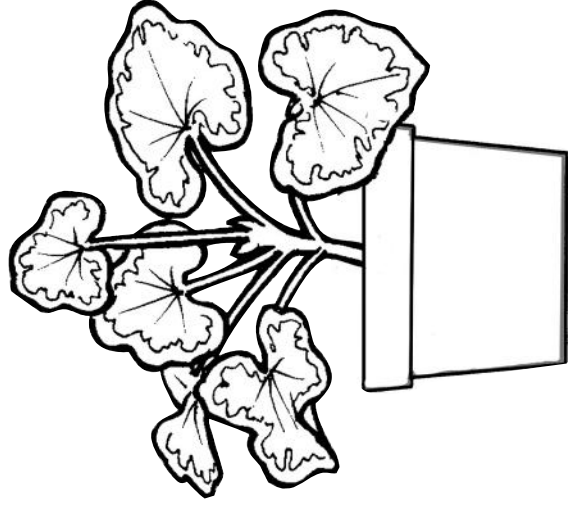

My plant needs light to make food in its leaves.  
*(Draw a picture of your plant getting light.)*

## My Plant Needs...

Air

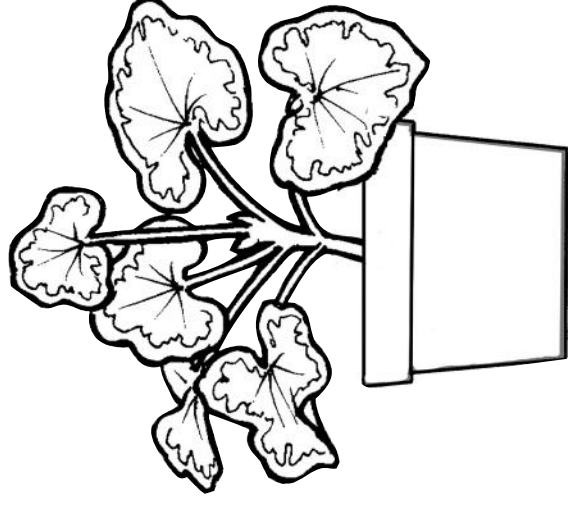

My plant needs air to make the energy it needs to grow.  
*(Draw a picture of your plant getting air.)*

# Mi Planta Necesita ...

Cuaderno de actividades

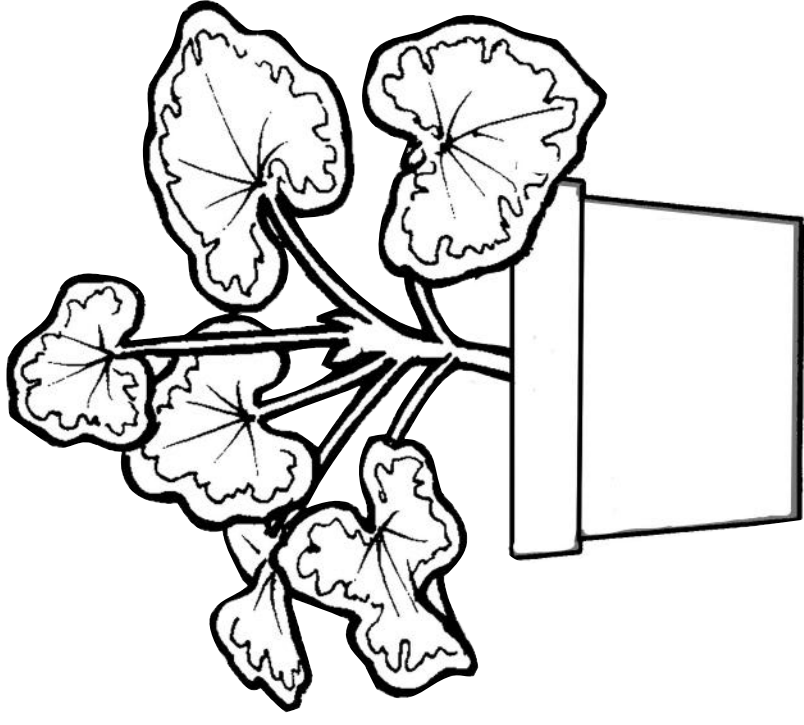

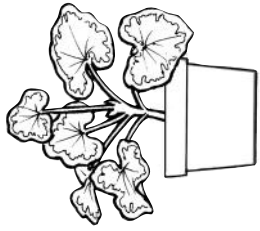

## Mi Planta Necesita... Por

---

## Mi Planta Necesita... Un Lugar para Crecer

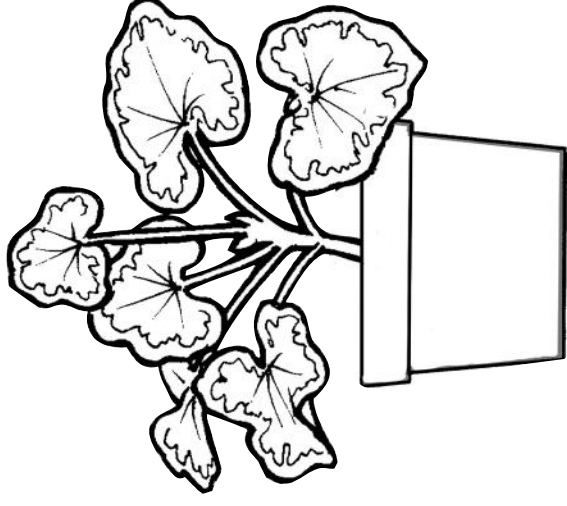

Mi planta necesita un lugar para crecer donde  
tenga espacio para sus raíces, tallos y hojas.  
*(Haz un dibujo de tu planta en su lugar para crecer).*

## Mi Planta Necesita....

Nutrientes

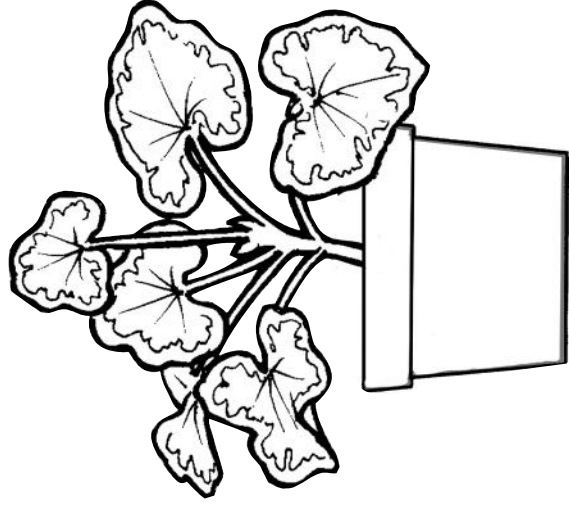

Mi planta necesita nutrientes para mantenerse viva y crecer.  
*(Haz un dibujo de tu planta obteniendo nutrientes).*

## Mi Planta Necesita....

Agua

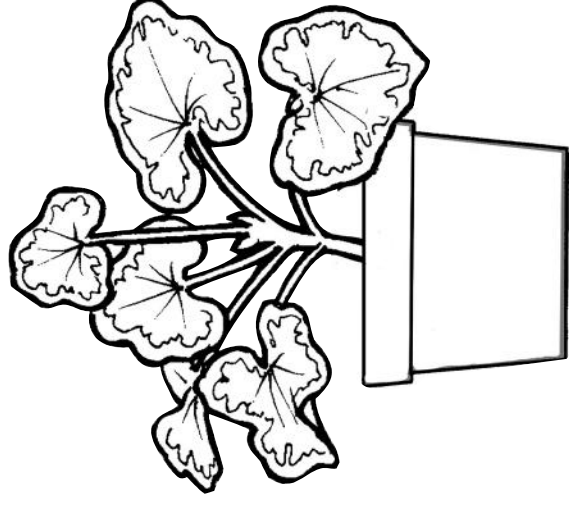

Mi planta necesita agua para producir alimento y mantenerse fresca.  
*(Haz un dibujo de tu planta obteniendo agua).*

## Mi Planta Necesita...

Luz

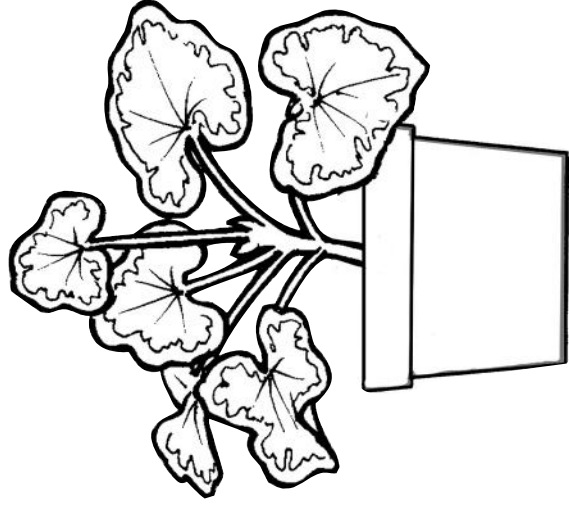

Mi planta necesita luz para producir alimento  
en sus hojas.  
(Haz un dibujo de tu planta obteniendo luz).

## Mi Planta Necesita...

Aire

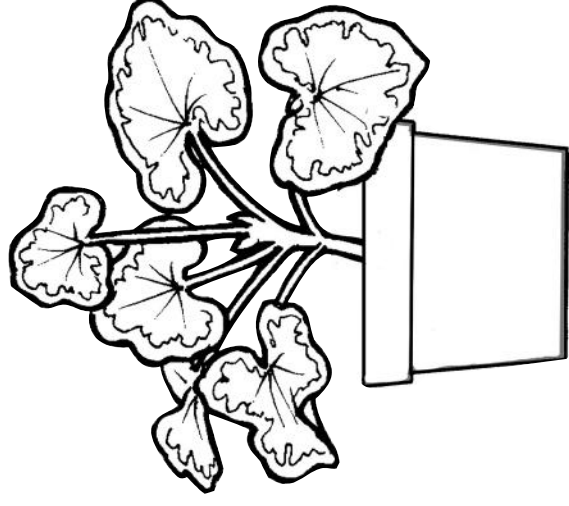

Mi planta necesita aire para producir la energía que  
necesita para crecer.  
(Haz un dibujo de tu planta obteniendo aire).

# DIY: SIMPLE STRAW HYDROPONIC SYSTEM

## Materials List

- Rockwool or cotton balls
- Seeds
- Small plastic containers with lids (margarine, cottage cheese, or yogurt)
- Hydroponic nutrient solution
- Plastic drinking straws

**1** Soak some small squares of rockwool or cotton balls in a dilute hydroponic nutrient solution (dilute according to product directions). Plant two or three seeds in each one, and then place them on waterproof trays or shallow containers and keep moist with water or nutrient solution until seeds germinate. Once your seeds have germinated and begin to grow roots, you can transfer them into your hydroponic system. Additional details about planting seeds can be found at: <https://kidsgardening.org/garden-how-to-starting-seeds-for-hydroponics/>.

**2** Find small plastic containers with lids to repurpose for each square or ball.

**3** Have an adult use a utility knife to carefully cut a 1-inch X shape in the center of the lid. Then cut a smaller X shape in the lid, about 1 inch from the edge, large enough to insert a drinking straw.

**4** Gently insert the rockwool or cotton ball with the seedlings halfway through the large X so that it is held securely in place in the lid.

**5** Fill containers with a dilute nutrient solution so that just the very bottom of the cotton ball or rockwool square will touch the solution, then secure the lid.

**6** Insert a drinking straw through the smaller holes in the lids of the containers and into the solution. Twice a day, gently aerate the solution by blowing into the straw.

*\*Classroom Note: Consider the ability and maturity level of your students when assigning this job. If you think your students may drink the liquid, rather than blow bubbles into the liquid, this needs to be a task for the teacher. If you think your students can be trusted to perform the aeration properly, make sure to prevent students from using the same straws and sharing germs – either label each container clearly so they know which one is theirs or remove and replace straws between treatments.*

**7** Monitor fluid levels and add nutrient solution as needed so it is just touching the bottom of the cotton ball or rockwool. Every 1 to 2 weeks, drain and refill.

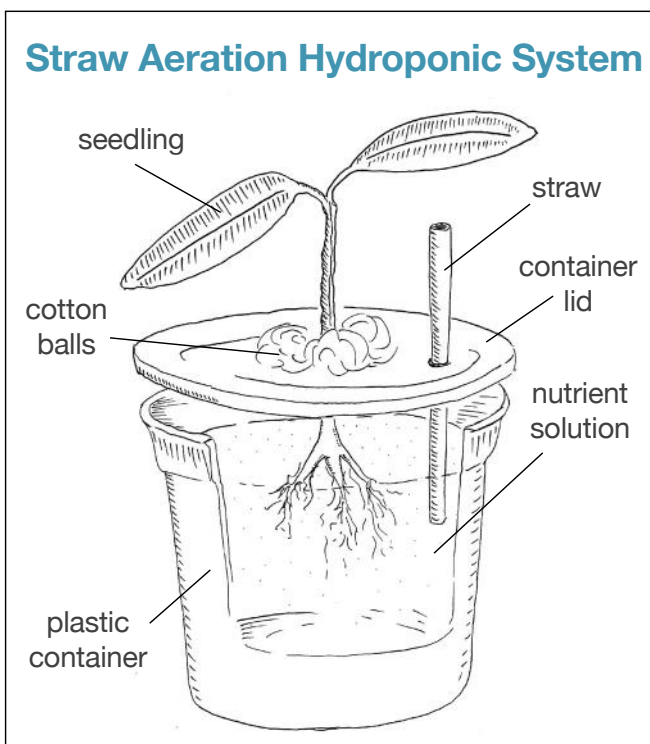



# DIY: SODA BOTTLE SYSTEM

## Materials List

- Rockwool or cotton balls
- Seeds
- Hydroponic nutrient solution
- 2-liter plastic bottle
- Aquarium tubing
- Aquarium pump
- Scissors and hole punch
- Aluminum foil, dark plastic, or paper
- Air stone (optional)

1 Soak some small squares of rockwool or cotton balls in a dilute hydroponic nutrient solution (dilute according to product directions). Plant two or three seeds in each one, and then place them on waterproof trays or shallow containers and keep moist with water or nutrient solution until seeds germinate. Once your seeds have germinated and begin to grow roots, you can transfer them into your hydroponic system.

2 Cut the top off of the soda bottle leaving a bit of the sloping neck. For this system, you will invert the top of the bottle into the bottom. The inverted top will hold your plant while the opening of the bottle will allow access to nutrient solution you will place in the bottom of the 2-liter bottle. After making your cut, check to make sure your top will securely fit inside of the bottom and also make a notation of where the bottom of the inverted bottle opening falls. You will need your nutrient solution to reach

this point. You can secure the top by punching holes and using a paper clip or string to connect the two if they do not feel sturdy on their own.

3 On the side of the bottom half of the 2-liter bottle above the future nutrient solution line, create a small hole so you can insert an aquarium pump tube. Insert aquarium tubing through the hole you made so that it reaches near the bottom of the bottle, but not touching the bottom. As an optional feature, you may want to consider attaching the submerged tubing to an air stone.

Air stones can be made of different types of materials, but in general are porous stones used to diffuse the air being pumped into water into smaller bubbles. The stone will also add weight to your bottle and help your tubing stay in place. It may also decrease the sound produced by your system.

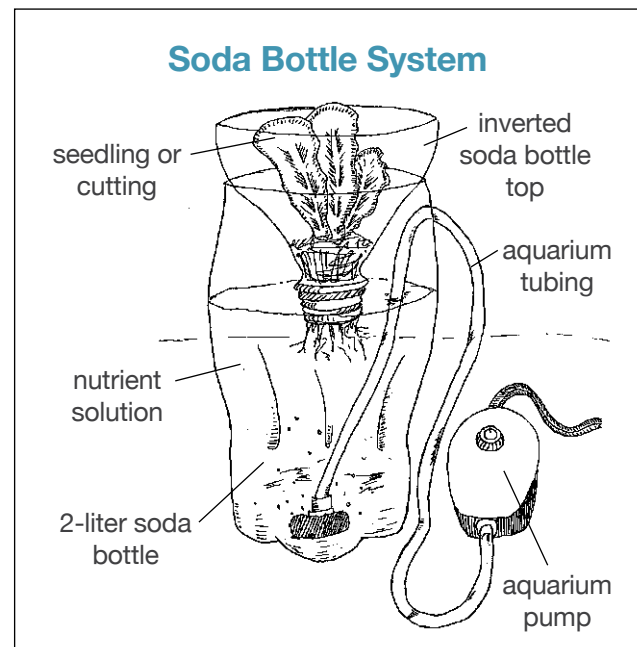

④ Connect the other end of the tubing not in the water to your pump.

⑤ Fill the bottom of the bottle with a nutrient solution until it reaches the point where the bottom of the inverted bottle top will be located. Place the rockwool or cotton ball containing your lettuce seedlings so that it securely fits into the main hole of the inverted bottle top. Then place the inverted top into the bottom half of the 2-liter bottle.

⑥ To discourage algae growth, wrap aluminum foil, dark plastic, or paper around the setup to exclude light from the water and roots.

⑦ Try to keep the nutrient solution pH between 5.8 and 6.5 and the temperature at about 70 F, and change it every two weeks or so. Some hydroponic growers suggest using a half strength solution for the first week.

## Soil vs. Hydroponics Data Collection Worksheet

Date	Height of tallest plant growing in soil	Height of tallest plant growing in hydroponic style	Describe any differences between the plants growing in soil and hydroponics:	Which plants do you think look healthier?	Notes

## Hoja de trabajo de recopilación de datos de suelo versus hidroponía

Fecha	Altura de la planta más alta que crece en el suelo	Altura de la planta más alta que crece en estilo hidropónico	Describe las diferencias entre las plantas que crecen en el suelo y las hidropónicas:	¿Qué plantas crees que se ven más saludables?	Notas

# LESSON 2

## Plant Parts

### Guiding Questions

What are the basic parts of a plant?  
What is the function of each plant part?

### Materials

#### Laying the Groundwork:

- An assortment of different types of potted/uprooted plants for students to explore. At minimum, have one sample with fibrous roots and one with a taproot. If possible, include examples of plants grown hydroponically and others growing in soil.
- Plant Part Worksheets (if live samples are not available)
- Classroom plant journals or the Plant Parts Observation worksheet (available at the end of the lesson).

#### Exploration:

- Fresh samples or cut-out pictures of assorted fruits and vegetables, with at least one representing each part of the plant. Possible options:
  - Roots: carrots, sweet potatoes
  - Stems: asparagus, Irish potato (\*Fun Fact - the Irish potato is actually an underground storage stem)
  - Leaves – lettuce, kale

- Flowers: broccoli, cauliflower
- Fruit: cucumbers, peppers
- Seeds: corn, dried beans

- Plant Part Cards (if samples not available)
- Paper plates or baskets labeled with the different parts of a plant

#### Making Connections:

- A variety of fruits and vegetables cut into various size pieces and representing different plant parts (fresh, frozen, or canned)
- 2 or more plates per student (one for cutting and one for eating for each child)
- Cutting utensils (optional)
- Toothpicks (optional)
- Dips such as ranch or yogurt (optional)

~ OR ~

- Seed catalogs, cooking magazines, and grocery store ads
- Paper
- Glue

### Extension (Optional):

- Assortment of craft or recycled materials to make a “plant” such as:
  - Mop handle (or other long stick)
  - String or string mop head
  - Construction paper or foam pieces (green and assorted colors)
  - Paper plate
  - Turkey baster or 20-oz. soda bottle
  - Pipe cleaners
  - Tape

*\*Materials listed can be easily substituted by other available craft or recycled materials.*

#### Time

**Laying the Groundwork:** 30-45 minutes

**Exploration:** 30 minutes

**Making Connections:** 30 minutes

**Extension:** 30 minutes

### Lesson Summary

Plants may be very different in appearance, but they all have similar parts. In this lesson, students investigate the different parts of the plant and discover what they do for the plant.

### Learning Outcomes

After completing this lesson, students will:

- Know all the basic parts of a plant.
- Understand the jobs each plant part performs for the plant.
- Explore how parts may look different on different plants but have the same function.

### Background Information

Plants come in all different shapes and sizes. Some are so small they could fit inside the palm of your hand; others are so tall they tower over our man-made structures. Despite their differences, they are all made up of similar basic parts that perform specific functions. Plant parts can be divided into two main categories: vegetative and reproductive.

The **vegetative** parts give the plant its structure and perform all the basic functions the plant needs to stay alive. The main vegetative plant parts are roots, stems, and leaves.

The **reproductive** parts are tasked with making the next generation of plants. The reproductive structures of most common plants are flowers, fruits, and seeds. However, that is not always the case. Some plants make seeds in cone structures, including many common evergreen conifers like pine trees. Other types of plants, such

as ferns, produce spores instead of true seeds. Since a majority of our edible plants produce seeds by way of flower and fruit, this lesson is going to focus on those three common reproductive parts.

Below is a brief introduction to each of the basic plant parts and their functions.

## Roots

It is the job of roots to absorb the water and nutrients a plant needs to grow and thrive. They also provide support for the plant and anchor it.

Some plants have one main root called a **taproot** with just a few smaller secondary roots. Reaching deep into the soil, these long, strong roots pull up nutrients from far below the surface. Dandelions are a common example of a plant with a taproot. Some taproots are specialized to also be a storage site for starches and sugars. Common examples of taproots with this capability include carrots, sweet potatoes, and beets.

Other types of plants have a **fibrous** root system — a network of small- to medium-sized roots that spread wide in the soil. Fibrous roots play an important role in soil stabilization and, even though they are not as deep as taproots, they may reach far beyond the footprint of the plant above ground. Grass plants are great examples of fibrous roots to study. One scientist measured all the roots of a single rye plant and found that if they were laid end to end in a line, their length would total 387 miles!

## Stems

Stems contain the plant's internal transport system. Inside the stems, water and dissolved nutrients absorbed by plant roots are moved up to the leaves where plants make their food. Once food is produced, it moves through the stems from the leaves to the rest of the plant and back to the roots. These separate functions are conducted through two types of cells. **Xylem** (ZIE-lem) cells transport the water and dissolved nutrients. **Phloem** (FLOW-em) cells transport the food made by the plant.

Stems complete a second very important function for plants. They are also tasked with providing structural support for the plant, allowing them to grow tall to reach the light their leaves need for food production. By lifting them off the ground, stems are also keeping plant leaves from being trampled on and in some cases eaten.

### STEM FUN FACT

Most stems are located above the ground, but not all. There are some plants that have modified stems that grow below ground and typically serve as food storage sites. Irish potatoes are an example of below-ground stems, along with true bulbs like onions and tulips. (Fun plant-part trivia: Irish potatoes are stems and sweet potatoes are roots.)

## Leaves

It is inside the leaves where plants perform the amazing feat of turning water, carbon dioxide, and energy from the sun into the food energy that all living things rely on for survival. Plus, as a bonus byproduct, this process also puts oxygen back into the air for us to breathe. Pretty amazing stuff! Check out the KidsGardening article [Photosynthesis Runs the World](https://kidsgardening.org/lesson-plan-photosynthesis/) for a more extensive description of photosynthesis:

## Flowers

Although we enjoy the beauty of flowers, their main purpose is to make seeds. This job is accomplished when the pollen, located on a **stamen** of a flower (usually there are multiple stamens) is transferred to the **pistil** (there may be one or more), another part inside the flower. This process is called **pollination**. The pollen transfer can be aided by wind and water; however, in many instances, flowers need the help of animals known as pollinators to move their pollen from a stamen to the pistil. In fact, the beautiful colors and attractive scents of flowers are characteristics developed to entice pollinators to visit — we just happen to reap some benefits, too. Once pollen is transferred to the pistil, the **ovary** at the base of the pistil will begin to develop into a fruit containing seeds.

## Fruit

Flowering plants produce seeds inside of ovaries which develop into fruits. Fruits serve to protect the seeds and also to help with seed dispersal. Although an apple or orange might be the first thing to pop into your mind when you hear the word fruit, the structure itself can be very diverse. Fruits range in appearance from a juicy watermelon to a hard pecan nut. Some fruits are considered “**fleshy**,” and this includes many of the fruits we eat, like a peach. Others are classified as “**dry**,” these may not always be recognized as being fruit, like elm and maple samaras (the “helicopters” or lightweight, winged fruits that spiral through the air). Sometimes each fruit will contain lots of seeds (apple), and other times it will just contain one seed (peach). A fruit can have a hard outer shell (pumpkin) or be soft (tomato). The range of what fruits look like and how they function is quite remarkable.

## Seeds

Seeds grow the next generation of plants. Inside every seed is a baby plant called an **embryo**. The seed also contains a lunchbox of sorts called the **endosperm**. The embryo is surrounded by stored food that is used by young plants until they can start making their own food through photosynthesis. Because seeds have their own source of nutrients to sustain the plants through early life, they do not require additional nutrients from the soil until their roots have time to become established. The proteins, fats, and carbohydrates stored for the benefit of the young plants are what make seeds such a rich and vital food source for humans and other animals.



## Laying the Groundwork

Working in teams or individually, provide your students with an assortment of different types of plants to explore. Ask them to record their observations in a classroom plant journal or use the Plant Parts Observation worksheet at the end of this lesson.

If you started hydroponic and soil-based plants in Lesson 1, your experimental plants can serve as your examples. If you use your experimental plants, just make sure students are very careful with the roots so they disturb the plants' growth as little as possible in order to be able to continue the experiment. Comparing hydroponic roots and soil-grown roots is a very interesting activity. The roots of hydroponic plants and soil-grown plants are quite different. Plants growing in hydroponic systems tend to have very long roots with not quite as much branching as you will find in soil-grown plants, which have to weave their way around obstacles under the ground or in potting soil.

Also, if possible, try to obtain at least one example of a plant with a taproot and one with fibrous roots for kids to compare. Possible taproot examples include carrots or beets from the grocery store (select ones that still have their leaves so your kids can picture what they look like when growing in the garden) and dandelions (a common weed found in lawns across the country; make sure to dig deep to get the full root). Although their root growth may change to a fibrous root system over time, many trees also start their lives with a taproot. If you can find tree seedlings in areas you do not want them (such as in flower pots or vegetable garden beds) you can pull them up for observation. For your fibrous root example, most grass plants have fibrous roots and can be readily found in yards and greenspaces across the country. Lettuce plants also provide really nice examples of fibrous roots, as do most annual bedding plants.

Also try to find one example of a plant with woody stems such as a shrub or tree and one example of a herbaceous plant (those with green stems) like most perennials and annuals.

In this activity, using live plant samples for comparison allows students to use all their senses to explore and provide added engagement. However, if you do not have access to live specimens, you can use the Plant Part Worksheets at the end of this lesson as reference for comparison instead.

Prompt your kids to observe differences and similarities in all of your samples. Ask them, "Do all of our samples have some similar parts? How do some of the parts look the same? How do they look different? How do you think these characteristics impact where the plant lives or how long it lives?" Add in a math exercise by asking students to count the various plant parts in your samples.

Another fun activity — if you can find plants with an abundance of blooms — is to let kids dissect the flowers and see all of the different parts. In some flowers you may even be able to dissect the ovary of the pistil to see the immature seeds forming. Make sure to explain to students that the flowers represent an important food source for pollinators — and once they make fruit possibly other animals too — so you will want to approach this activity in a scientific manner and let them know it is okay to pick some to study, but you do not want to over-harvest the blooms.

Summarize your observations by creating a class list of all the major parts of the plant. Ask students to surmise the function of each part of the plant based on their observations and prior knowledge. You can supplement your class-generated list of parts and their functions with details from the Background Information as appropriate.

Review what you have learned about plant parts through a movement activity. Have students close their eyes, take a deep breath and think about what it must feel like to be a plant. Ask them to imagine their feet are roots. Ask them to wiggle their toes and reach out to look for water and nutrients. Next ask them to imagine their bodies are stems. Do they stand tall or do they need to bend to reach more sun? Next, picture their hands are leaves. Are they moving in the wind? Are they extended as much as possible to grab sunlight? Are they busy as they are making the food for the plant? Finally, ask them to pretend their faces are flowers. What kind of face would they make to attract pollinators to help them spread pollen and make their fruit?

## Exploration

① Share that we eat different parts of different plants. Bring in a variety of samples of different fruits and vegetables, making sure to have at least one representative for each part of the plant. If fresh produce is too expensive or unavailable, you can also just use laminated pictures, play food, or the Plant Part Cards at the end of this lesson. Here are some ideas:

- **Roots:** beet, carrot, radish, sweet potato, turnip
- **Stems:** asparagus, garlic, white potato
- **Leaves:** cabbage, lettuce, parsley, spinach
- **Flowers:** broccoli, cauliflower
- **Fruit:** apples, avocados, cucumbers, green beans, peppers, squash, tomatoes
- **Seeds:** corn, peas, rice, sunflower seeds

② Ask students to list the parts of the plant and write each down on a separate paper plate (or on a piece of paper to add as labels to baskets). Spread the plates and/or baskets out in the front of the classroom.

③ Next, play a sorting game. Depending on the comfort level of your students, you can sort your samples all together as a group, or give each student a sample and have them take turns placing them into the category they think they fit into.

④ When you finish sorting, take time to look at each group and talk about what they have in common. For example, all of the fruits will contain seeds. Most of the leaves will be green, etc. Alternatively, if time allows, instead of a group discussion, you can spread out the different collections of parts to create discovery stations for the students to explore individually or in teams, so they can get more hands-on in inspecting the samples. Ask them to document the similarities and differences they discover among all the parts.

\*At some point in this activity, make sure to also mention to students that even though we eat different parts of the plant, we do not eat all parts of all plants. Some plants and some parts of plants can contain chemicals that can make us sick. You may want to share the example of tomatoes. Tomato fruit is tasty; however, tomato leaves are poisonous if eaten in large quantities. Reinforce that we should only eat plant parts that we know are safe and are grown with the intention to be eaten.

## Making Connections

Make learning about plant parts fun and delicious by giving students a chance to taste a variety of fruits and vegetables representing different parts, while also creating a consumable work of art. You can use cooked or raw, and fresh, canned, or frozen foods depending on availability and age of your students. See list in Exploration for ideas.

Start this vegetable art snack activity by preparing the produce you collected. Wash and dry fresh fruits and vegetables, and then cut them into bite-sized pieces and place in a bowl or on a plate. Prepare frozen or canned fruits and vegetables as needed (cook, thaw, and/or drain and rinse). Depending on the age and skill level, allow children to help with prep as appropriate. Plastic knives may work well for many items and can be safe for young children. You can use small cookie cutters in the shapes of circles, stars, etc. or a melon baller for additional options.

Give each child a second plate to serve as a workspace and then set them loose to create a picture or mini sculpture using the fruits and vegetables provided. Depending on their age, you can also give them toothpicks to help their creation take form. They can complement their art work with dip or dressing.

If your kids need some inspiration, author Saxton Freymann has a collection of books featuring creatively carved fruits and vegetables you may want to check out.

Once complete, snap a photo of each creation to document their art. Use the photos to help the kids create a storybook featuring their fruit and veggie creations. Have them take one last look to enjoy the beauty of the creations and then start eating.

If obtaining or preparing fruits and vegetables to eat is an obstacle for you, an alternative activity is to collect old cooking magazines, seed catalogs, or the grocery store ads from old newspapers and give kids the chance to cut out pictures of fruits and vegetables representing different plant parts. Ask them to try to find at least one example of each part and label it. With these pictures they can create colorful and fun collages highlighting the different plant parts we eat. Their artwork can even be laminated and used as educational placemats to encourage healthful eating habits.

### Extension (Optional)

Reinforce your lesson on plant parts by building a model plant! Building a larger-than-life plant is an engaging way to teach kids all about its different parts. The following instructions provide plant part material suggestions. However, you can use a wide assortment of craft and/or recycled materials for this project. Just take a look around and creatively use whatever is available to you.

You can start with a mop handle or alternate rod-like item and ask students what plant part they think it represents. The stem! Use the background information to explain the basic functions of a stem.

Next, use regular string or pieces of a string mop and attach roots to your plant. Explain why roots are so important to a plant — and even beyond the plant, to our soil and environment.

Continue by adding leaves. Leaves can be crafted in any shape using green construction paper or foam pieces. Explain that most leaves are green because they contain a special compound called chlorophyll that helps the plant make its own food using the energy from sunlight... the food that every other living creature depends on too!

Finally, make a flower. There are many ways to do this, but a paper plate can provide an easy base. Attach a paper plate to the top of your mop and then kids can attach petals of any size, shape, or color to the plate. In the center place a turkey baster or 20 oz. soda bottle to represent the pistil and surround the pistil with pipe cleaners to represent the stamen. Share with students that even though we appreciate the beauty of flowers, their purpose is to make fruit and seeds, and ultimately new plants.

To ensure the highest level of engagement during the building of your model, have enough pieces (roots, leaves, flower petals, pistil, and stamen) so that each of your students can contribute at least one to the construction of your plant.

Students can repeat this activity at home using found craft items and then bring in their plants to share with the class. Give them time to show off their creations and highlight their plant parts and their functions.

# Plant Parts

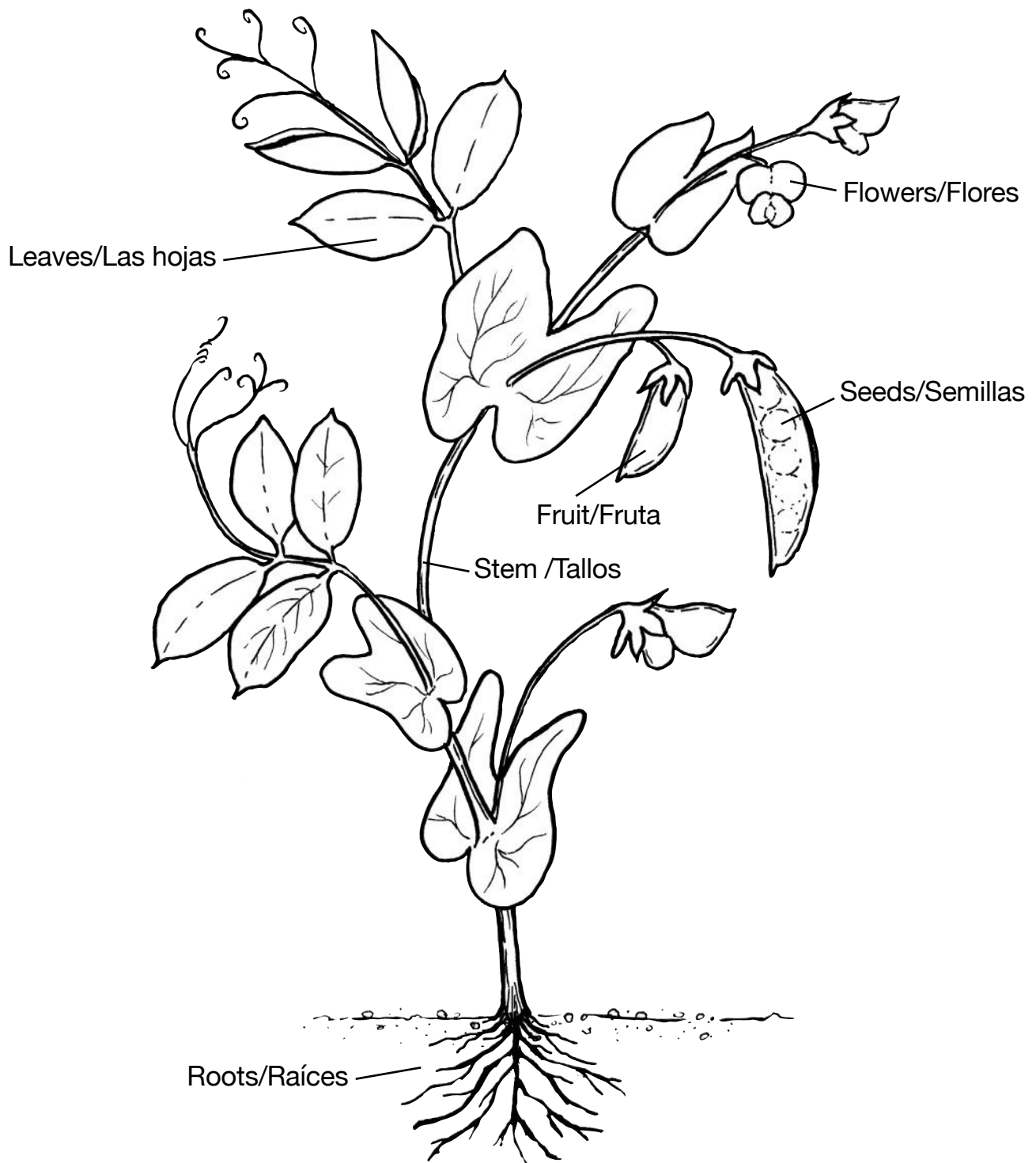

# Plant Parts—Fibrous Root

## WORKSHEET

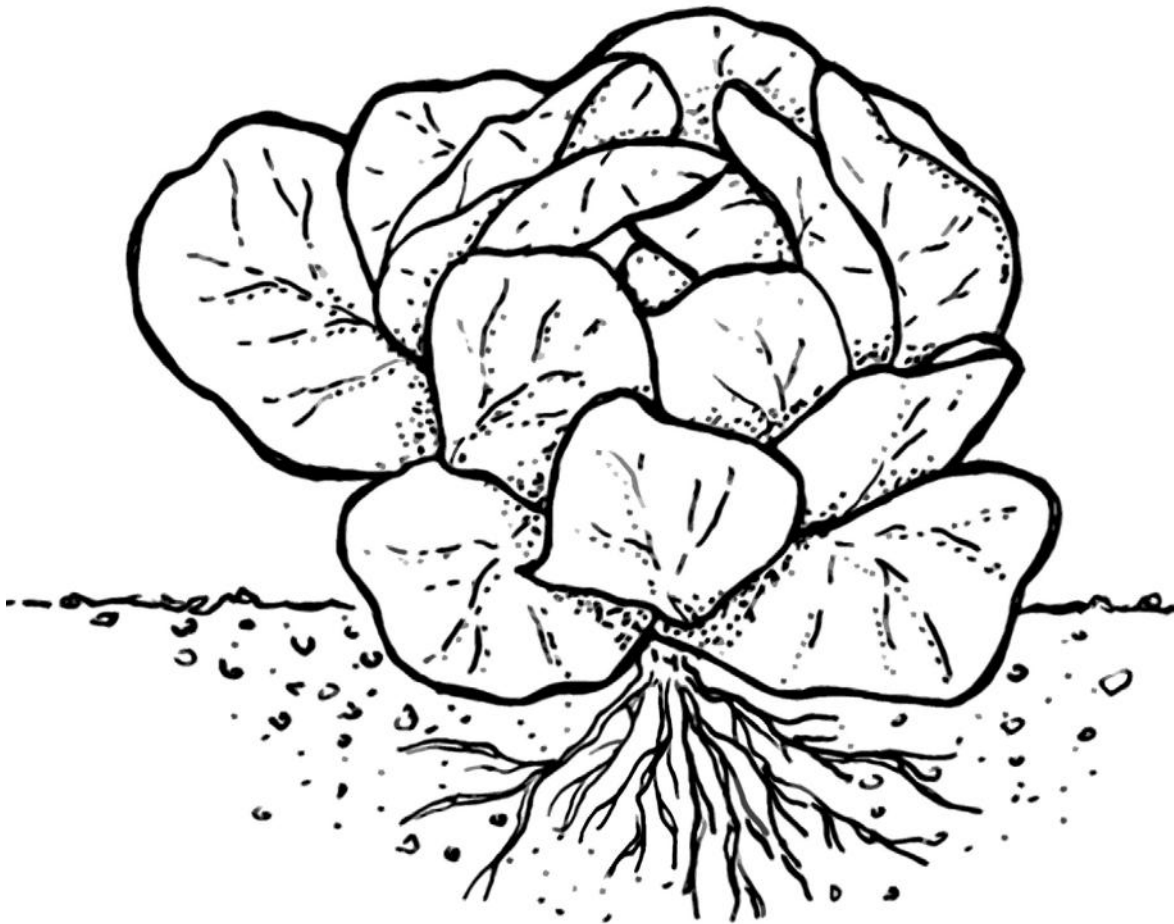

# Plant Parts—Tap Root

## WORKSHEET

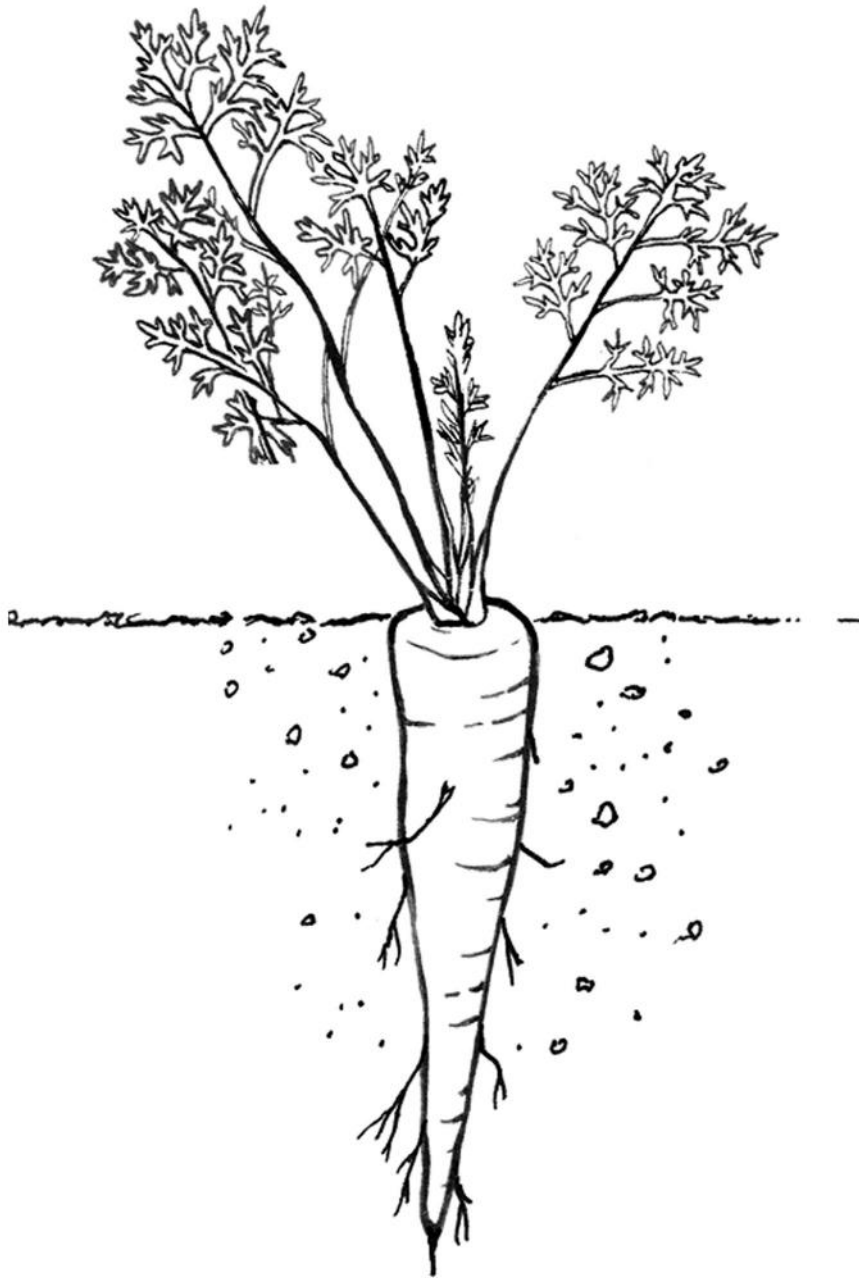



## Plant Parts Observation worksheet

Draw and Label the Parts of Your Plant	What kind of roots does your plant have? Tap or Fibrous	What kind of stems does your plant have? Woody or Herbaceous (green)	What shape are the leaves?	Additional observations:

## Hoja de Trabajo de Observación de Partes de las Plantas

Dibuja y rotula las partes de tu planta	¿Qué tipo de raíces tiene tu planta? Principal o fibrosa	¿Qué tipo de tallos tiene tu planta? Leñosos o herbáceos (verdes)	¿Qué forma tienen las hojas?	Observaciones adicionales

## Plant Parts Cards

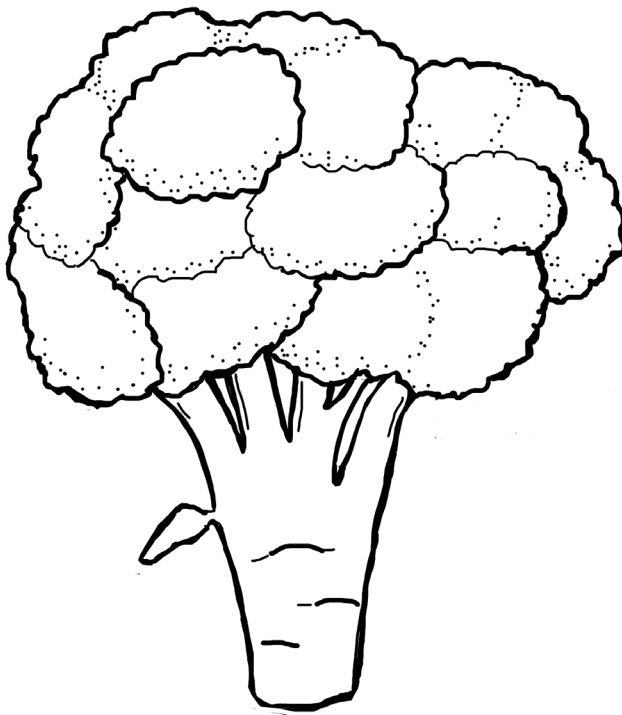
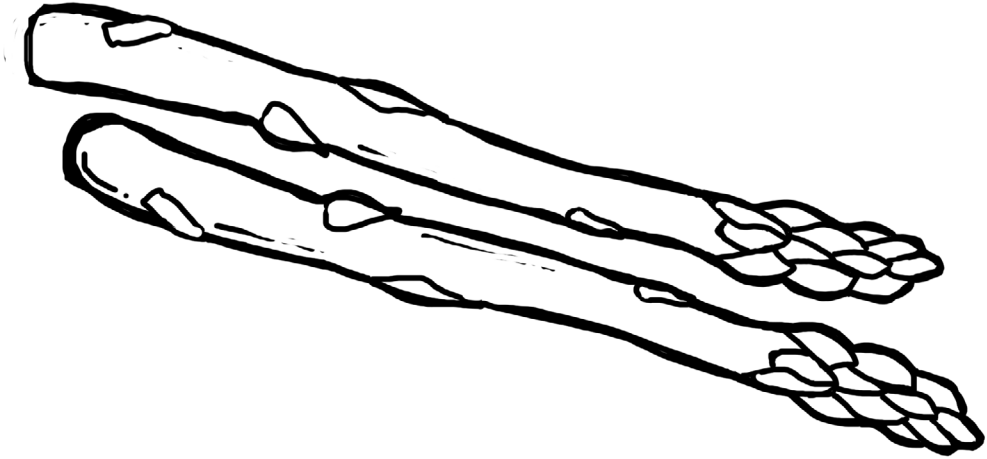

## Plant Parts Cards

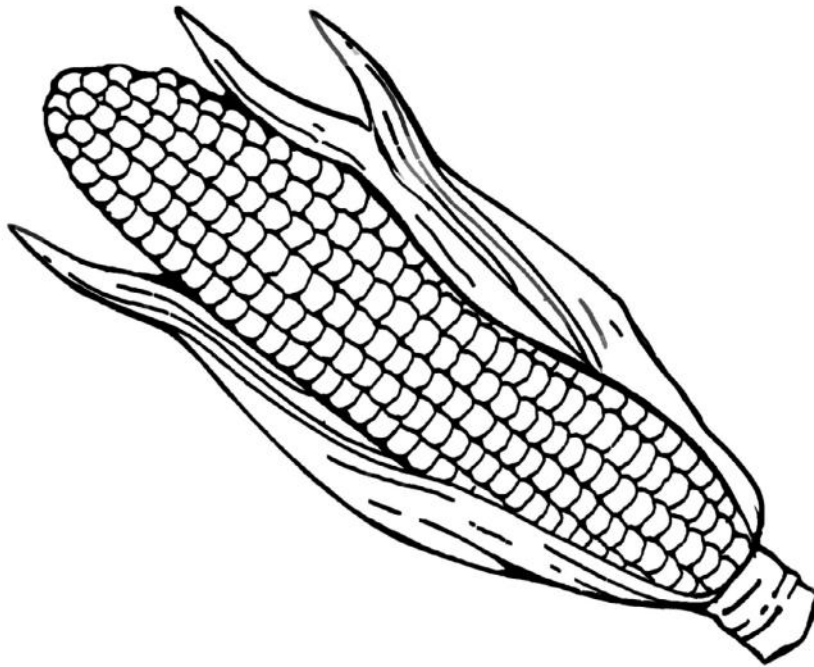
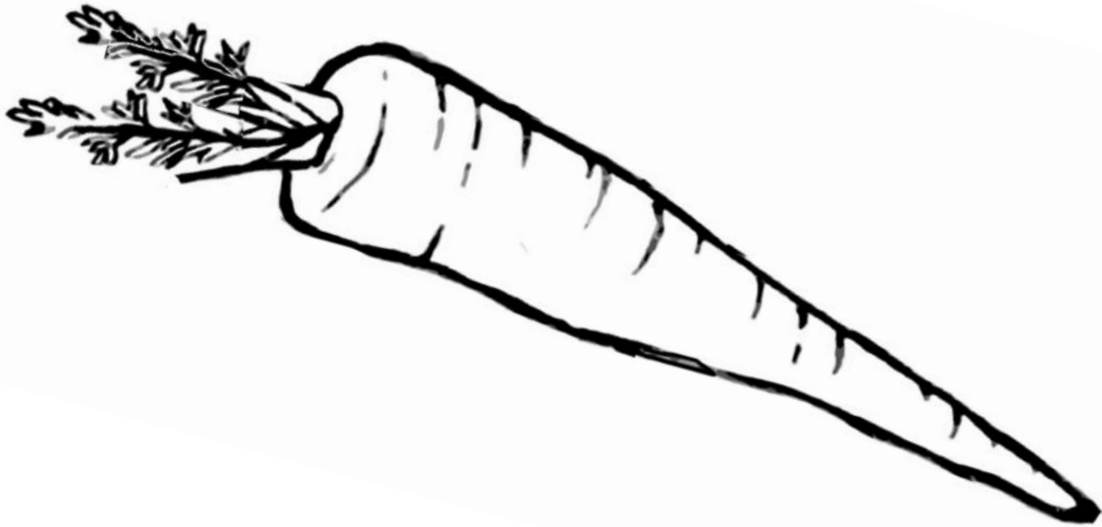

## Plant Parts Cards

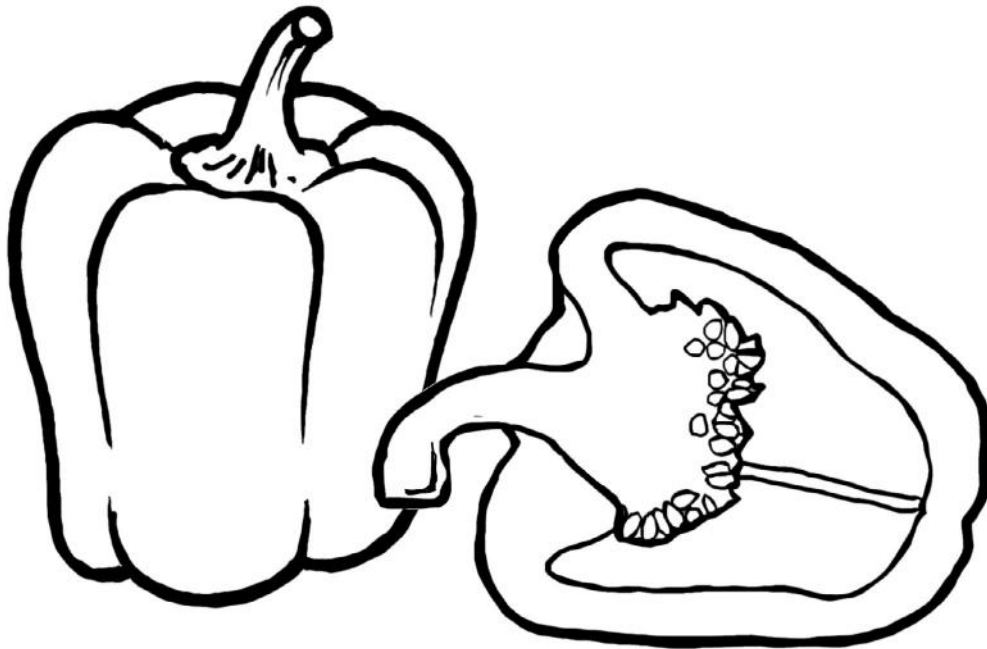
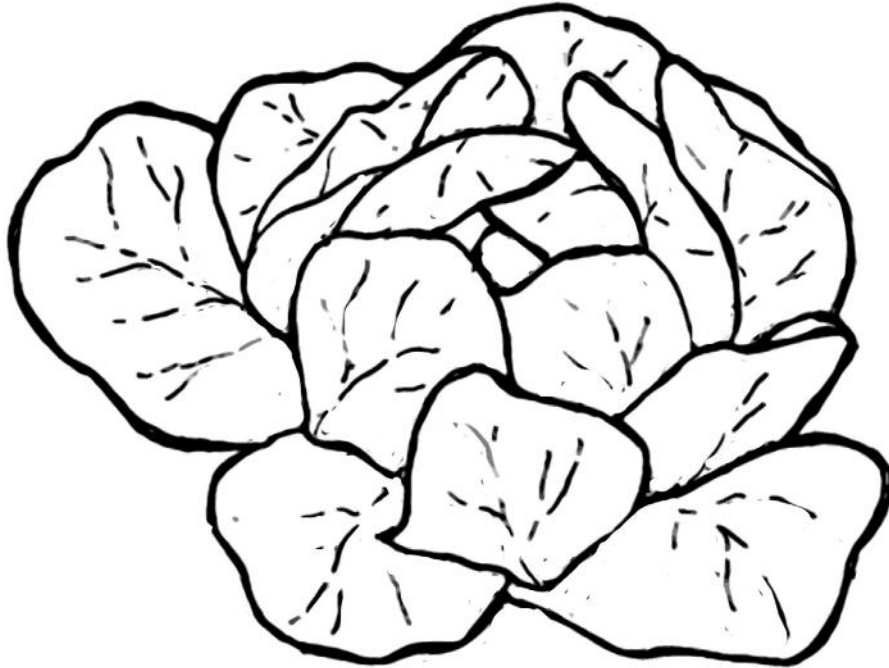

# LESSON 3

## Plant Life Cycle

### Guiding Questions

What are the stages of a plant's life cycle?  
How do plants change in each stage of their life cycle?

### Materials

#### Laying the Groundwork:

- Lima beans (from the dried bean aisle at the grocery store)
- Paper towels
- Inside a Seed Observation Page (available at end of lesson)
- Diagram of the Inside of Seed (available at end of lesson)

#### Exploration:

- Fast-growing seeds such as lettuce, beans, and tomatoes
- Hydroponic system or potting soil-filled planting containers
- Grow lights

~OR~

- Assorted fruits with seeds from the grocery store (easy-to-grow possibilities include citrus fruits like oranges, lemons, grapefruits, and limes; peppers; tomatoes; watermelon; and avocado)

- Potting soil
- Small pots or empty and clean milk cartons
- Plastic sandwich bags
- Garden journal page

#### Making Connections:

- Plant Life Cycle Cards (available at the end of lesson)

#### Extension (Optional):

- A readers theater play

### Time

**Laying the Groundwork:** 30-45 minutes

**Exploration:** 2-3 weeks

**Making Connections:** 30 minutes

**Extension:** 30 minutes

### Lesson Summary

From seed to seed, plants grow and change in each stage of their life cycle. Explore how plant needs and plant parts change as the plant grows.

### Learning Outcomes

After completing this lesson, students will:

- Know and be able to put in order the stages of a plant's life cycle
- Understand plants change as the plant grows.

## Background Information

A plant begins its life cycle as a seed. When presented with the right conditions, the seed sprouts (a process known as germination) into a young plant called a **seedling**. It then matures as leaves and stems grow and multiply, eventually producing a fruit or a cone (or sporangia in the case of ferns) that contains new seeds. Then the cycle begins again.

### Planting Seeds

Growing a plant from seed is a perfect way to introduce young children to plant life cycles. The dramatic change from something that does not look alive into a green, ever-changing organism is remarkable. Below you will find some basic instructions for successful seed-starting activities:

### Seed Germination

The embryo, a tiny new plant inside the seed, lies in a dormant state protected by the seed coat. The seed also contains stored energy that sustains the seedling until it can begin producing its own food. When the seed is exposed to the right conditions, it sprouts. This step is called **germination**.

Most seeds just need moisture and warm temperatures for germination. Some seeds need special treatment beyond that for germination to begin. These special treatments evolved as survival mechanisms. For example, seeds of many northern plants need a certain amount of exposure to cold temperatures before they will germinate. This keeps a seed from sprouting in the fall, when conditions for seedling survival are declining as winter begins. Some plant seeds (pansies, for example) germinate better in the dark; others, like lettuce, require light.

When you purchase seeds, most will include instructions on the back of the seed packet. Any special germination requirements will most likely be listed there. If you want to germinate seeds you've collected from the wild, you and your students can conduct an Internet search to learn about any special conditions required for germination.

### How to Sow Seeds

You can plant seeds directly outside or start them indoors and transplant them later. Some plants grow better when planted directly in the soil, including beans, peas, sunflowers, lettuce, radishes, beets, carrots, peas, cucumbers, and squash. Others, such as tomatoes, impatiens, mint, are more successful when started indoors. Still other plants, such as marigolds and zinnias, perform well whether sown indoors or out.

### To plant outside:

- Mark your garden area, and remove all existing vegetation, including weeds and grass. If you leave existing plants in the same space, those more mature specimens will have an unfair advantage over your young seedlings in the competition for resources.
- Loosen the soil with a shovel or trowel. Plant your seeds. Follow the instructions on the seed packet to determine the planting depth and spacing between seeds. If the instructions don't mention how deep to plant the seeds, a good rule of thumb is to place them one-and-a-half to two times as deep in the soil as the seed is wide.
- After planting, water new seeds using a gentle soaking mist or sprinkle. A strong stream of water may cause seeds to float to the lowest part of the garden.

### To plant inside:

- Find shallow containers (2 to 3 inches tall) with drainage holes. You can purchase plastic flats designed specifically for seed starting or use something as simple as an egg carton with holes punched in the bottom.
- Fill the containers with a lightweight soilless potting mix. These mixes are usually free of weeds and disease organisms that may hamper growth. Moisten the mix in a large bowl or tub before placing it in the planting container. The mix should feel moist to the touch, like a damp sponge, but not wet. If you squeeze a handful and water drips out, add more dry mix to your bowl.
- Plant seeds according to the instructions on the back of the packet. If the instructions don't mention how deep to plant the seeds, a good rule of thumb is to place them one-and-a-half to two times as deep in the soil as the seed is wide.
- Water the seeds after planting, using a spray bottle adjusted to a gentle mist.

Place the seed trays in a warm, humid location. Most seeds germinate best at around 75 degrees. Cool-season crops, such as lettuce, prefer cooler room temperature. Light may or may not matter at this stage depending on the type of seeds you are planting. There are some seeds that require light and others that require dark to germinate, however others do not have a preference.

You can increase humidity by covering the seed tray with plastic wrap until the seeds germinate.

- As soon as you see your first sprout, remove the humidity cover or plastic bag and place the tray in a sunny windowsill or under lights.



### To plant seeds for hydroponic systems:

Although some hydroponic systems (including most prefabricated systems) allow you to plant seeds directly into the setup, other systems (especially DIY ones) work best if you start seeds in a medium such as rockwool cubes placed in a tray of water/nutrient solution, and then transfer them into the hydroponic system once the roots have begun to grow.

Rockwool cubes are convenient and readily available from hydroponics suppliers. These cubes are made from molten rock that is spun into fibers and then compressed into cubes. They're fibrous, slightly spongy, drain freely, and provide plenty of pore spaces for air and water — both vital for healthy root growth. They even have a hole in the top for the seeds. Other non-soil options are perlite, coconut coir, and even cotton balls! Instructions for planting in rockwool cubes are below.

- Start by pouring a gallon of lukewarm water into a shallow basin. Add enough hydroponic nutrient concentrate to create a half-strength solution. (For example, if the packaging says to add a cup per gallon for your hydroponic system, add a half-cup.)
- Soak the cubes in the diluted solution for a half hour to ensure they're completely saturated.
- Place the cubes on a watertight tray and allow excess solution to drain.
- Gather your seeds for planting. Plant one or two seeds in the holes in the tops of the cubes.
- Add a humidity cover to hold in moisture, which will help speed germination. You can also place the cubes in a loosely tied plastic bag.
- Place the covered tray in a warm spot. Most seeds germinate best at around 75 degrees. Cool-season crops, such as lettuce, prefer cooler room temperature.
- Check the tray daily. If the cubes start to dry out, mist them with the same dilute nutrient solution, or “bottom-water” by adding the solution to the tray and allowing the cubes to soak up the solution. After an hour or so, pour off excess solution so the cubes don't become waterlogged.
- As soon as you see your first sprout, remove the humidity cover or plastic bag and place the tray in a sunny windowsill or under lights.
- Once a seedling's roots have begun to fill out the cube, it's ready to transplant into your hydroponics system!

## Germination Rates

Even the freshest seeds won't result in 100 percent germination. Seeds may experience damage from the environment (too dry, too wet), they may not be fully mature, or they may possess genetic defects that hamper growth. Plant a couple of extra seeds for every one plant you want to grow, then thin out any extras later by snipping off the extra seedlings at the soil line.

## Caring for Indoor Seedlings

Young plants are called seedlings. They are less resilient than full-grown plants and require more attention on your part. For instance, you must test the moisture of the growing medium regularly and water enough to keep it moist but not wet. If you wait until the seedlings wilt, they may not bounce back.

New seedlings need lots of light. Outdoor plants in full sun may receive 6 to 8 hours or more of bright sunlight a day. Indoors, a sunny windowsill may suffice for a few weeks, but most seedlings will grow better if provided with supplemental light. The light from fluorescent or LED grow lights is less intense than direct sunlight, so use a timer to turn the lights on for 14 to 16 hours a day. If seedlings look leggy or grow toward a window, they aren't getting enough light. Move windowsill seedlings under grow lights, or adjust the height of the light fixtures, positioning them 3 to 6 inches above the seedlings.

## Nourishing New Plants

As mentioned above, seeds contain not only an embryo, but also stored energy (the cotyledons) that the plant lives off at the beginning of its life. For plants grown in potting mix, you don't need to provide any additional nutrients or fertilizer until the plant has three or four true leaves. Hydroponic plants receive nutrients through the hydroponic solution.

## Laying the Groundwork

To prepare for this activity, soak some lima beans (enough for at least two for each student) in water for 2 hours to overnight. Don't soak them all; you need some dry seeds to start the activity.

Begin your exploration by giving each student a dry lima bean seed to observe. Have them draw a picture of their seed on the Inside a Seed Observation Page (available at the end of the lesson). Ask them to turn to a neighbor and ask each other: "What does the seed look like? What does it feel like?" Ask the teams to share some of the adjectives they came up with to put on a classroom observation chart.

Next, distribute the lima bean seeds that have been soaked in water along with a paper towel. It is best if you have enough for at least two seeds for each student. Ask them to draw a picture of what the wet lima bean seeds look like. Again, they can turn to a neighbor and ask, “What does the wet lima bean seed look like? What does it feel like? How is it different from the dry lima bean seed?” Again, add some of their observations to your classroom chart.

Finally, demonstrate for students how to carefully dissect their seed: Begin by peeling away the seed coat which should be loose after being soaked in water. Then, very gently, split their seed in half. Ask them to draw what they see in the last column of their Inside a Seed Observation page. Give them time to compare their findings to their neighbor. Then ask the class to share what they found. What do they see inside? What do you think the different components you found do?

After giving them time to share their discoveries, explain that inside each seed is a baby plant, called an embryo. (Sometimes the embryo will break when the seed is split, which is why it is good to have at least two seed samples for each student.) Pass out copies or show students the diagram found on the Inside of the Seed worksheet (available at the end of the lesson). Point out all of the different parts of a seed.

Finish up the activity by showing a time lapse video of a seed germinating such as the Bean Time-Lapse by GPhase at: <https://www.youtube.com/watch?v=w77zPAAtVTul>.

Alternatively, you can also use the Seed Viewers in Lesson 1 to document the development of a seed in a garden journal.

## Exploration

There is no better way to introduce students to a plant’s life cycle than by watching a plant grow “from seed to seed.” Ideally, students can plant seeds, and observe them as the plants grow and produce flowers, and then fruits. Ultimately, the students can harvest ripe seeds from the fruits. If you have a lighted hydroponic unit, outdoor garden, or indoor grow lights (which can be used for growing soil-based plants or using hydroponic growing methods), plants that are relatively easy to grow from seed to seed include beans, lettuce, peppers, cherry tomatoes, and Wisconsin Fast Plants®.

The reason it is recommended that you have access to indoor lights or an outdoor space to grow plants from seed to seed is that it takes a lot of energy for plants to produce seeds. They must flower and set fruit to make seeds and in order to do that they must have access to adequate light and the right temperatures to reach maturity.

Hydroponic units are excellent tools to help you demonstrate this process in the classroom. Because nutrients are readily available in the hydroponic solution, if you can combine the perfect nutrient blend with adequate light and temperatures, plants growing in a hydroponic unit have the potential to grow faster than those growing in soil.

That being said, due to time constraints and environmental conditions across educational settings it might be challenging to observe plants from seed to seed; therefore, the following activity is an alternative idea for exploration.

- 1 Harvesting and planting seeds from common fruits and vegetables available at a grocery store or farmer's market is another way to help students understand the life cycle of the plant. By starting with the product at the end of the plant's life cycle (i.e., the fruit that contains the seeds), this activity provides them with a different perspective than just starting seeds they plant from seed packets, which they may not be able to follow to maturity.
- 2 Begin by collecting fruits with easy-to-sprout seeds. This list includes citrus fruits like oranges, lemons, grapefruits, and limes; peppers; tomatoes; watermelon; and avocados. If possible, allow students to cut open the fruits and harvest the seeds on their own, although be prepared to provide assistance as needed. **Note:** There are some fruits that we may commonly call vegetables (e.g., tomatoes), even though they are, botanically speaking, really fruits because they have seeds in them.

The plant list above was chosen because their seeds germinate fairly easily with the common conditions of moisture and room temperatures. You are welcome to try other fruits or even have the kids bring in their own samples from home; however, there are many common fruits whose seeds must have some kind of specific treatment to germinate. For example, apple seeds need exposure to a certain amount of time of cold temperature before they will begin to grow, an adaptation that is critical to their survival in the wild in their native climates. If you choose to include other fruits in your experiment, you may want to research germination requirements with your students and learn more about the survival mechanisms of seeds.

To incorporate math practice, add on a counting activity by having students note the number of seeds collected from each fruit. They can compare how many they find in different fruits and different kinds of fruits. They can also compare size, shape and weight of the fruit and the number of seeds found.

- 3 Wash the seeds collected and remove any pieces of fruit attached to the seed. Let the seeds dry for a couple of days (although not too long, because you don't want them to dry out too much).

**4** Prepare containers for planting. You can grow the plants hydroponically or in potting soil. If you choose to grow hydroponically, follow the directions provided by your prefabricated unit or use the instructions in the Background Information for starting seeds in rockwool. If you do not have a prefabricated unit, there are many DIY models described in Lesson 1 and Appendix B of this guide.

If you are growing in potting soil, you can use small gardening pots or repurpose milk cartons or food storage containers. Just make sure your containers have drainage holes in the bottom. Add moist soil and then plant your seeds.

**5** After planting, cover your containers with plastic bags to trap extra humidity (making sure that the plastic does not touch the soil but rather gives the plant room to grow like a tent) and place seeds in a warm location. Ask students to consider why they think seeds need moist conditions and warm temperatures to grow? Why is this a survival skill of the baby plant?

**6** As the plants grow, use the care information from the Background Information to talk about how the plants' needs are changing. To begin growing, many seeds only need moisture and warm temperatures. Seeds contain enough stored energy and nutrients to help support their initial growth. As young seedlings, they run out of stored energy and nutrients and must have access to light and nutrients so that they can make their own food through photosynthesis. Explain to students that just like people need different amounts of food, nutrients, and water depending on their age, the amount of water, nutrients, and light plants need will continue to change throughout their life.

**7** Grow the plants for as long as possible. Although it may not be possible to watch them grow to maturity in your classroom, you may want to consider transplanting them to an outdoor space for continued observations.

## Making Connections

Make copies of the Plant Life Cycle Cards which depict the different stages of growth for a bean plant. Have students sort the cards and place them in the correct order as one large group, in teams, or individually. You may want to enlarge the cards if you plan to use this as a group activity.

If you started experimental plants in Lesson 1, based on your observations and research, have students create life cycle cards specifically depicting the plants you are growing. Create a display of the cards to teach others about your experiment.

## Extension (Optional)

Once students have explored the order of growth, ask them to act out the life cycle of the plant. Begin the activity with a mindfulness exercise where you ask kids to close their eyes, breathe deeply, and spend a few quiet minutes thinking about what it must feel like to be a seed. Seeds contain all of the supplies they need to start growing, but they are patiently waiting for the final inputs they need to begin to grow (water and warm temperatures). Ask, “What do you think you would feel like as you wait to grow? Would it feel like you were sleeping? Would you be excited? Would you be bored? How would it feel when the conditions are right to grow? Imagine what it would feel like to wake up. Would you want to wake up slowly or would you want to wake up fast?”

To act out the life cycle, students can be divided into groups to make team skits. (Some students could be seeds and other students could be acting out activities such as planting the seeds, watering, providing sunlight.) Alternatively, one educator or student could lead the group to be seedlings all together. A possible skit could include actions such as starting out in a ball as a tiny seed, spreading legs and feet to represent roots, standing up to unfurl, representing a stem, and lastly spreading out arms and hands to represent leaves to catch the sun.

If you would like to make this a reading activity, older students and more advanced readers can use a reader’s theater play about life cycles to guide their continued exploration.

Little Lyrical Learners on Teachers Paying Teachers offers a lifecycle focused reader’s theater play about sunflowers at <https://www.teacherspayteachers.com/Product/The-Life-Cycle-of-a-Seed-BUNDLE-Leveled-Scripts-and-Vocabulary-Cards-4617622>.

**Inside a Seed Observation Page**

Draw your bean seed before adding water:

Draw your bean seed after it has been soaked in water:

Draw what you find on the inside of your bean seed:

**Página de Observación Dentro de una Semilla**

Dibuja tu semilla de frijol antes de agregar agua:

Dibuja tu semilla de frijol después de que haya estado empapada con agua:

Dibuja lo que encuentres en el interior de tu semilla de frijol:



# Diagram of the Inside of Seed

## WORKSHEET

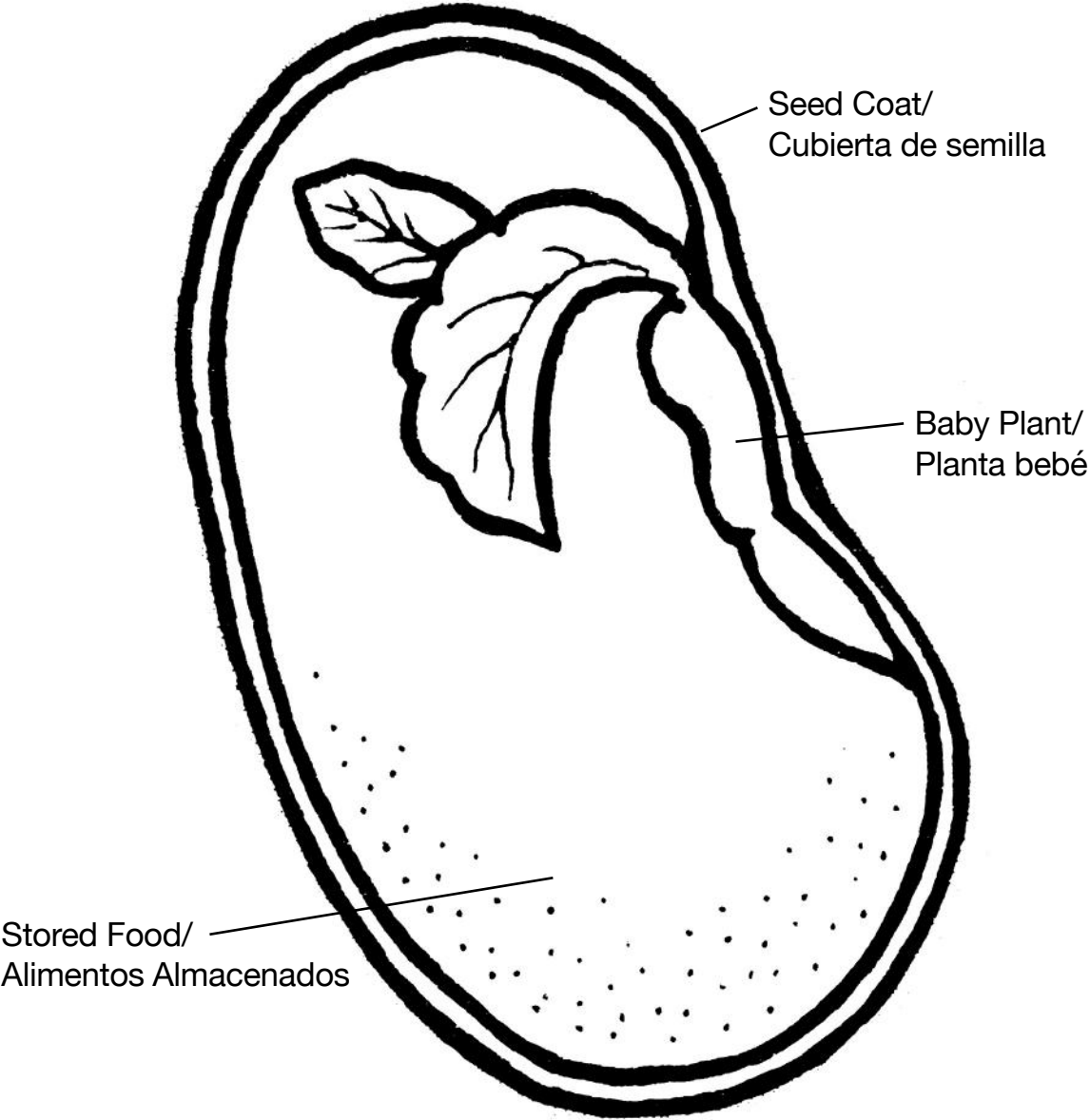

## Garden Journal—Measure the Height of Your Plant Each Day

### Seeds Planted:

Plant #	Date:	Date:	Date:	Date:	Date:	Date:	Date:	Date:	Date:

**Página del Diario de Jardinería—Mide la Altura de tu Planta Todos los Días.**

**Fecha en que sembraste las semillas:**

Planta #	Fecha:	Fecha:	Fecha:	Fecha:	Fecha:	Fecha:	Fecha:	Fecha:	Fecha:

# Plant Life Cycle Cards

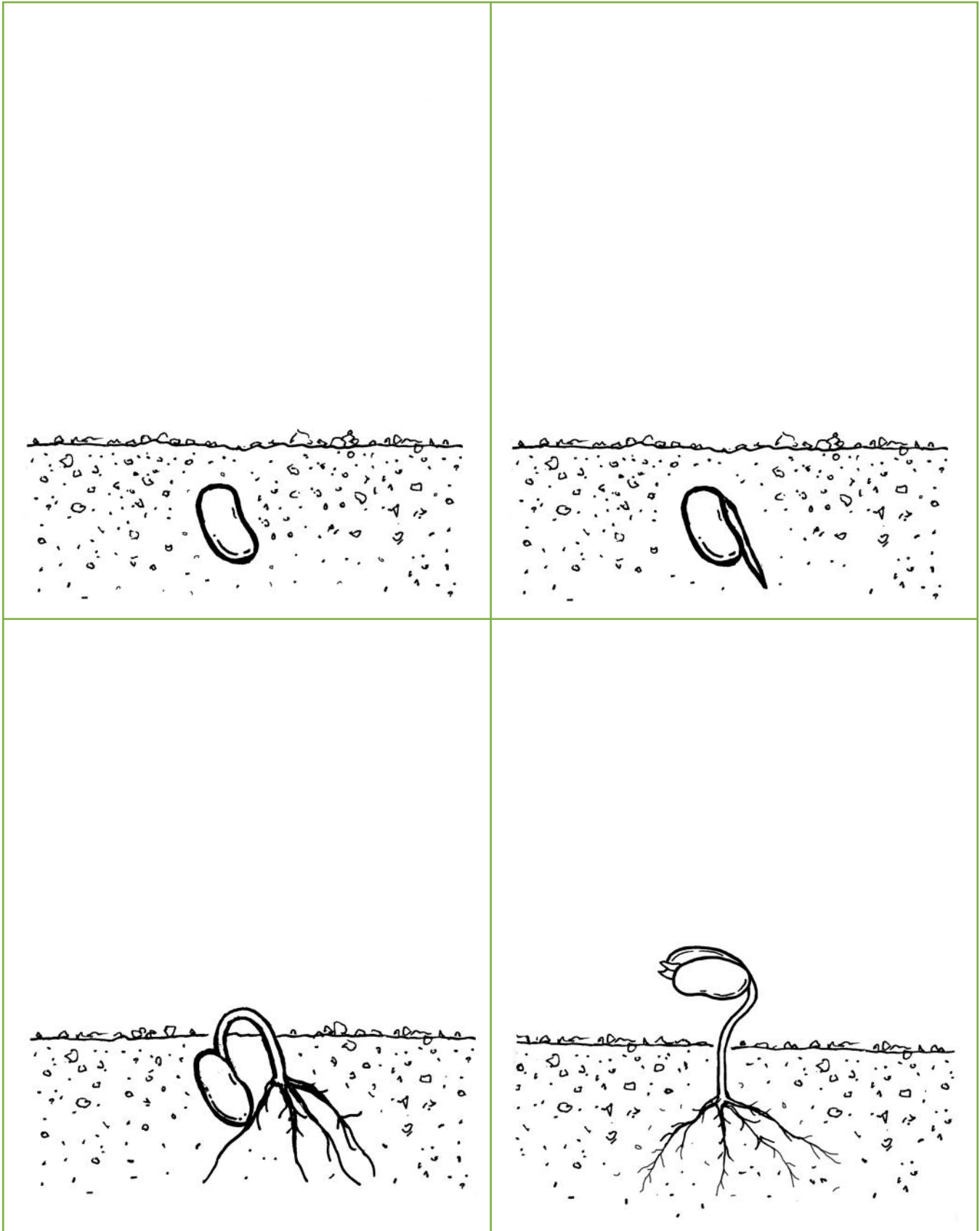

# Plant Life Cycle Cards

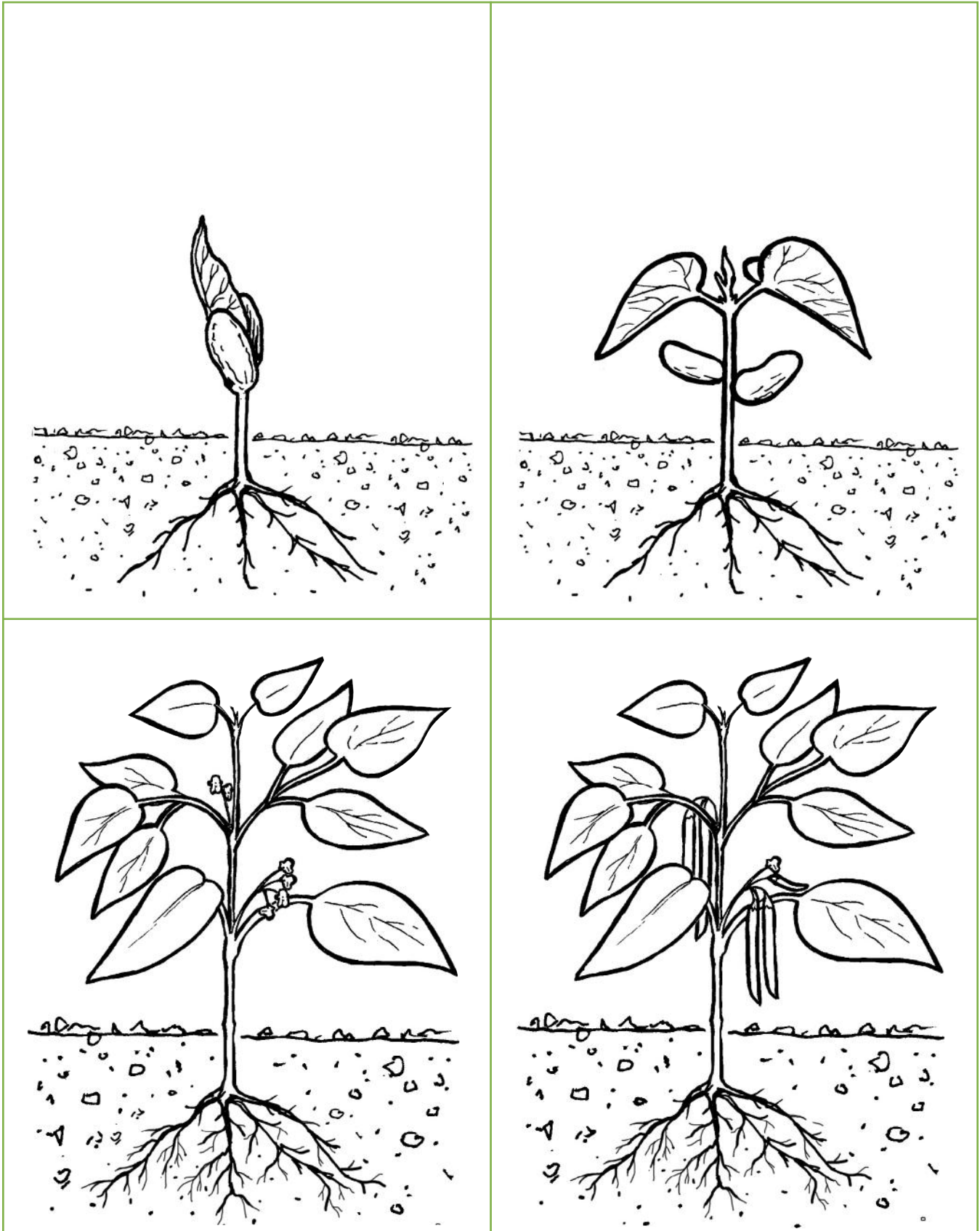

# LESSON 4

## Farm (& Garden) to Table

### Guiding Questions

Why are plants important to people?  
Where does our food come from?  
Who is involved along the path that our food takes from field to table?

### Materials

#### Laying the Groundwork:

- Collection of processed food packages from the grocery store
- Where's the Plant? worksheet or coloring page (available at end of lesson)

#### Exploration:

- Internet access to watch videos
- Paper
- Pencils, crayons, or markers

#### Making Connections:

- Hydroponic- and soil-grown lettuce (for tasting)
- Hydroponic vs. Soil Taste Test worksheet (available at end of lesson)

#### Extension (Optional):

- One or more multicultural farm to school children's books

### Time

**Laying the Groundwork:** 30-45 minutes

**Exploration:** 30-45 minutes

**Making Connections:** 30-45 minutes

**Extension:** 30 minutes

### Lesson Summary

We depend on plants for the food we eat, the air we breathe, and so much more. They are an essential part of our ecosystem and our food system. Starting at a farm, there are many people who help get the food that is grown in the field to our table.

### Learning Outcomes

After completing this lesson, students will:

- Know that all life on Earth depends on plants.
- Understand that plants are at the base of all food chains.
- Explore the path of plants from farm/garden to our tables.

## Background Information

---

We rely on plants and a host of plant-made products to meet our basic needs. They play an indispensable role in our ecosystem, too. They are key to air, water, and soil health. They give off the oxygen we need to breathe, stabilize the soil, and help clean our water. In addition to our physical health, plants contribute to our social-emotional health, too. Researchers have found that spending time in green spaces helps us relax, can reduce stress, and strengthen a sense of community.

Of prominent importance to the survival of all living creatures is the role plants play in our food systems. Plants are the producers at the bottom of every food chain, due to their amazing ability to transform the energy of the sun into food (i.e., carbohydrates) through photosynthesis. Every living thing, including humans, rely on plants for the energy that keeps us alive.

Before modern day transportation innovations, most of the fresh foods people consumed were grown locally. Kids grew up with firsthand experiences demonstrating the connections between plants, people, the environment, and their food supply. They could often trace the origins of most of the items on their table.

Today, much of our fresh produce is shipped thousands of miles and we rely heavily on processed and packaged foods that do not look anything like what is grown on the farm. Children have only a vague idea of the history of food production in our country, as well as where food currently comes from, how it is produced, and who produces it. Additionally, very few understand the important link between the environment and their food. Youth gardens can help resolve this disconnect by increasing their knowledge and experience about how to grow food and enhancing personal connections to the land.

In addition to discovering how food grows (i.e., production), students must be introduced to other important components of our food system, including processing, packaging, transportation, and sales. Here are some key concepts to share with students about each step of the process:

# Food System

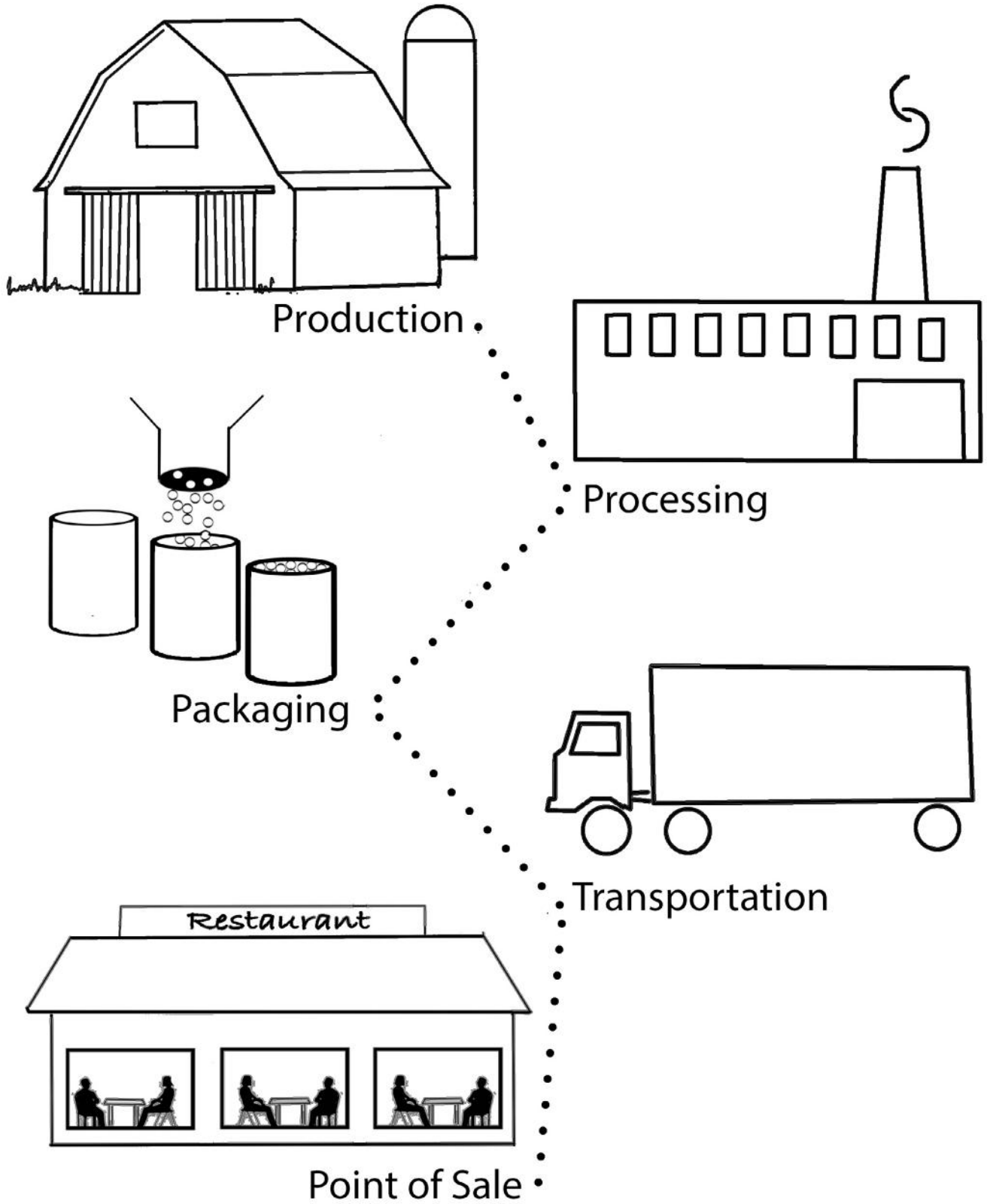



## Production

From horticultural crops like fruits and vegetables, to field crops like wheat and corn, plants provide the base of all of our foods — even the animals we eat must be fed plants to grow. Farming operations vary greatly in size from a few acres to thousands of acres, but all rely on the expertise of highly trained farmers and the hard work of many field workers to produce our food. Some crops, like corn, can be harvested with machinery. Other crops, like strawberries, must be carefully picked by hand.

## Processing

Some products are minimally processed. For example, many fruits and vegetables are simply cleaned and then boxed for shipping by farmworkers. Other food items are processed by people in processing facilities with the help of just a few ingredients, such as canned, frozen, or juiced fruits and vegetables. An even greater portion of food items in our grocery stores today are highly processed with added salt, sugars, and stabilizers and transformed into more complex products, such as boxed meals and special treats. In 1916 a grocery store sold about 600 items. Today, grocery stores sell thousands of products. Did we discover new edible foods? Probably a few, but most of this astronomical growth in the number of food products reflect our ability to create a myriad of new products from existing ingredients.

## Packaging

Once processed, our food is packaged for safety, preservation, and convenience. There is a wide range of packaging used in our food system. An apple may get a sticker that helps you know its variety. Other foods will be completely surrounded in packaging materials such as plastic, cardboard, and glass. Even fresh foods that are minimal processed, such as carrots, are available pre-washed and packaged in handy snack sizes. Packaging is also used to entice shoppers to try new products with promises like tastiness, convenience, and nutrition.

## Transportation

Food is transported across the globe by captains, pilots, conductors and truck drivers (and ultimately by consumers in cars and buses on the ride home from the grocery store.) According to the Center for Urban Education about Sustainable Agriculture (<https://cuesa.org/learn/how-far-does-your-food-travel-get-your-plate>), our food travels an average of 1,500 miles from the farm to our table.

## Point of Sale

In addition to the steps of growing, processing, packaging, and transporting our food, there's an additional step: distributing the food to the consumer, which may involve supermarkets, convenience stores, farmer's markets, and even restaurants.

Our vast and complex food system requires the hard work of many people during each step during the process of getting food to our plates.

When you think about the number of people and the amount of energy required, does our food system seem efficient? Is it sustainable? How much labor and energy go into moving our food around the country before we can eat it?

Our current food system has many challenges. To name a few:

- Our food travels long distances to get to our table, racking up food miles and increasing global carbon emissions. Many industrial agricultural practices have negative impacts on our soil, water and air quality.
- Farmworkers (and others involved in food production) along with food service workers frequently do not earn a living wage and are not guaranteed safe working conditions.
- Fresh fruits and vegetables, whole grains and other unprocessed foods are unaffordable and inaccessible to many rural and urban communities.
- People are eating an increasing number of processed foods, which is resulting in widespread negative health impacts.

The good news is that there are communities and advocates organizing around these issues, building rural and urban local food oases and pushing for more sustainable, healthier and equitable food system policies.

Many diverse efforts are being made to increase local food production and foster a more equitable food system, such as:

- organizing community gardens in empty lots
- maximizing the use of backyard gardens
- establishing Community Supported Agriculture (CSA) programs to connect local farmers with dedicated customers
- advocating for legislation addressing food and land access, land and resource conservation and sustainable growing practices
- developing technology like vertical hydroponic gardens built inside warehouses

There is also growing recognition of the important work of the people involved in food production and how much we rely on them. Taking a people-centered approach to understanding the food system paves the way for students to build empathy for each other and humans more broadly, begin to understand how communities work together to achieve a goal, develop systems thinking skills and possibly influence their future eating and purchasing habits.

Identifying the parts of the food system also supports students in their understanding of where food comes from and can be an opportunity for kids to reconnect with the land. Ultimately, the goal of educating youth (and adults too) about our food system, is to inspire the next generation to work towards a more sustainable and just process with priority on ensuring food security is available for all.

## Laying the Groundwork

- 1 Encourage students to think about the food we eat. Ask, “Where does our food come from?” Make a list of all their answers. Do they respond with a restaurant or a grocery store name? Do they suggest it is made in a factory? Did anyone mention a farm?
- 2 Next break the class into small groups and hand each group a processed food product from the grocery store (you can use the packages with or without the food inside). You may want to check with your cafeteria to see if they might have any leftover or discarded food packages that you can use for this activity. For young children, try to select items that have a fairly short list of relatively simple ingredients with few preservatives; possibilities include some brands of baked corn chips, applesauce, whole wheat crackers, cheese, yogurt, canned or frozen vegetables, and instant oatmeal.
- 3 Ask each group to find the list of ingredients for their food product and write it down on the *Where’s the Plant? Worksheet* (available at the end of the lesson). Beside each ingredient, ask them to check off whether they think the item is a plant.
- 4 Come back together and give each group time to share their product and findings. Make a list of all the non-plant ingredients on a chalkboard or white board.
- 5 Once you have a list of all the non-plant items, lead the kids to explore how many of the non-plant items could be linked back to plant items. For example:  
Cheese – comes from milk – which comes from cows – that eat plants
- 6 Ask, how many ingredients on our list did not lead back to plants? Based on our findings, ask them to consider the question, “Are plants important to people?”

\*An alternative for young children who are pre-readers is to use the *Where’s the Plant Coloring Page* located at the end of this lesson. Ask kids to color all the items that are made from plants. Get back together as a group and make a list of all the products they did not color as listed above. Again, try to determine how many of the non-plant items on the coloring page can be traced back to plants (which will be all of them). End by asking, “Are plants important for people?”

## Exploration

1 Show students one or both of the following videos about growing lettuce and spinach using hydroponic techniques:

### San Diego Hydroponic Farm from CaBountiful (6:40 minutes)

<https://www.youtube.com/watch?v=zod-246VCkg&t>

### Hydroponic Spinach: How Does it Grow from True Food TV

<https://www.youtube.com/watch?v=tG9bV2enwI0>

2 After watching the videos, ask “What happens to the lettuce or spinach before it gets to our table? How many people are involved?” Give each student a piece of paper and ask them to chart out a map of the path the food takes from field to table (using words or pictures, whichever is appropriate for the age of your students). Ask them to list each stop the food makes along the way.

3 After they have a chance to map out their own paths, have them share their findings in small groups or with the class. If they have missed any of the steps listed in the Background Information above, guide them to think about those additional stops along the path.

As an alternative for younger and/or kinesthetic learners, set up stations in the classroom representing each stop on the path from farm to table and have students role play a product moving through the system. Represented stops and their roles may include:

- **Production:** This station would represent a farm or garden that grows the produce.
- **Processing:** This station would represent a place for cleaning and preparing the harvest.
- **Packaging:** This station would represent a place where a label is placed on produce or a container is made and filled.
- **Transportation:** Students could model moving their products by car, truck, train, plane, or boat to consumers.
- **Point of sale:** This station would represent a farmer’s market or grocery store where consumers purchase the product.
- **Table:** Lastly, they could act out eating the product at home or school.

What this version of the activity may look like: Draw an apple on a piece of paper. Divide the class into groups representing each stop and then move your apple from stop to stop. Begin at the production stop and ask those students to act out what they would do with your apple on their farm or garden (such as take care of the apple trees, pick the apples). Next, hand your apple off to the processing facility where your apple is sorted and cleaned (ask students to act out washing the apples). Perhaps you will then turn it into juice or applesauce (students can act out press apples, chop them into small pieces). Following the production facility, take your apple or apple product to the packaging where it gets a label or container (students could pretend or actually design a prototype of a label or container). Next, transport your apple to the store or farmers market. At the point of sale, have students act out selling the apple or apple product to consumers. At the last stop, students would demonstrate eating the apple or apple product at a meal or snack.

④ Conclude the activity by posing some additional questions about our food system (select the questions below that would be appropriate for the age of your students):

#### **Production:**

Can we grow food anywhere? Do you have to have soil to grow food? Do you need the right weather to grow food? Who grows our food?

#### **Processing:**

Do all foods need the same amount of processing? Do processed foods use more or fewer resources than unprocessed foods? Where are foods processed? Who is involved?

#### **Packaging:**

What are the benefits of packaging? What resources are used to make packaging materials? What happens to the packaging materials after you consume the food? Is all packaging necessary? How are foods packaged (machines, people, etc.)?

#### **Transportation:**

What costs are involved in transporting food? Are there alternatives to shipping food long distances? What are the benefits of growing mass quantities of food in one location and transporting it? Are there any downsides? How many different people are involved in transporting our food?

#### **Point of Sale:**

Where can we buy our food? Are some places more convenient than others? Do all people have the same access to the same foods? Are fresh, nutritious, and affordable fruits and vegetables readily available to everyone, year-round? Who sells, prepares and serves our food?

## Making Connections

Hydroponic growing methods are being explored as a way to increase local access to fruits and vegetables. Hydroponic methods have benefits such as using less space and water, and can be used in areas where land or climate present challenges. But does hydroponic produce taste different than soil-grown produce?

Hold a taste test to compare hydroponic-grown and soil-based produce. If you started a hydroponic and soil-based crop in Lesson 1, you can use your own harvest for your taste test. You can also obtain sample plants from a local farmer's market or grocery store. Hydroponically grown crops are generally labeled as such, and are often located with other specialty produce, although you may need to do a bit of research to confirm. Lettuce and other greens, cucumbers, and tomatoes are examples of crops that are commonly grown in both types of systems and may be readily available at your supermarket.

You can use the Hydroponic vs. Soil Taste Test worksheet at the end of the lesson to encourage students to use their senses to compare. Before tasting their samples, make sure they take the time to record other sensory observations. Ask, what does each sample look like, what does it smell like, what does it feel like? Did your senses help you determine any differences between the two samples?

You can also pose additional questions to encourage mindful eating practices. Before you take that first bite, who can you thank for that food? The worms that nourished the soil, the sun for helping it grow, the rain for watering it, the gardener or farmer who tended it. As they are chewing their sample, ask them to chew slowly. Is there a sound it makes while you chew? How will this food help your body grow?

After tasting their samples, ask students to vote on their favorite and share why. Ask them to explain their votes on the observations they made during their sensory exploration. Did they make their choice based on smell, touch, taste or appearance of the sample?

If you purchased your samples, try to find out where the produce came from and figure out how far it traveled to get to you. You can also share with students the difference in prices between the two products. Expand your discussion to include the differences in cost and environmental impact of each sample. Ask students, "Should we consider the price and environmental impact of producing the food when we decide which product we like better?"

If you are not able to locate any hydroponically grown food, alternatively, you can also host a taste test that explores differences between fresh and processed fruits and vegetables. For instance you could compare ready to eat vegetables with those that must be washed and prepared (lettuce, spinach, carrots are all common examples that are often sold ready to eat). You could also compare examples of frozen, canned and fresh produce.

## Extension (Optional)

Explore farm to table topics through children's literature: The Pennsylvania Head Start Association and The Food Trust have launched a program called Ready, Set, Grow! to help inspire educators to incorporate farm to school programming. As part of their resources, they have developed a list of multicultural farm to table children's books that feature farmers and characters from underrepresented racial and ethnic groups. Choose one more books off their list at <http://www.pareadyssetgrow.org/book-list/> to help introduce your students to the many diverse voices and stories involved in growing, harvesting, and preparing our food.

For older or more advanced students, consider expanding your discussion and exploration to reflect on the cost of and energy needed at each stop on the path from farm to table.

According to the USDA, one-fifth of what is spent on food actually goes to the farmer and the rest goes towards packaging, transportation, and marketing (AskUSDA, July 2019: <https://ask.usda.gov/s/article/what-percentage-of-retail-food-prices-goes-to-farmers>). Assign a value to your end product and then figure out how much of that amount might be spent on each stop. Ask students, what stop(s) along the supply chain (farmer (growing inputs, farm management), farmworker (labor for cultivating and harvesting), packaging, transportation, etc.) do you think costs the most? What stop(s) along the supply chain do you think should receive the most of any given dollar spent on a food item? Why?

Also explore the environmental impact of our current food system in terms of energy use. What inputs are needed to grow the food? How much energy does it take to ship the food over long distances? How much energy do we spend buying the food and bringing it home?

Vermont FEED offers a lesson titled The Life of a Tomato that looks at cost and energy use while also exploring the issue of food justice that you may want to check out at: <http://farmtoschool.tbaisd.org/wp-content/uploads/sites/9/2015/08/LifeofaTomatoLesson.pdf>. This lesson investigates how the different paths tomatoes can take to get to our table alters the amount of money farmers earn for their work.

For even further investigation, introduce students to the issue of food insecurity: The nonprofit organization Learning to Give offers a series of lesson plans for students in K-2 around the topic of Global Health: Hunger and Food Around the Globe at: <https://www.learningtogive.org/units/global-health-hunger-and-food-around-globe-k-2>.

# Where's the Plant?

## WORKSHEET

Product Name: \_\_\_\_\_

Ingredient	Is this ingredient a plant?



# ¿Dónde está la planta?

## HOJA DE TRABAJO

Nombre del Producto: \_\_\_\_\_

Ingrediente	¿Este ingrediente es una planta?

# Where's the Plant?

## COLORING PAGE

Color all of the food products that have plant ingredients.

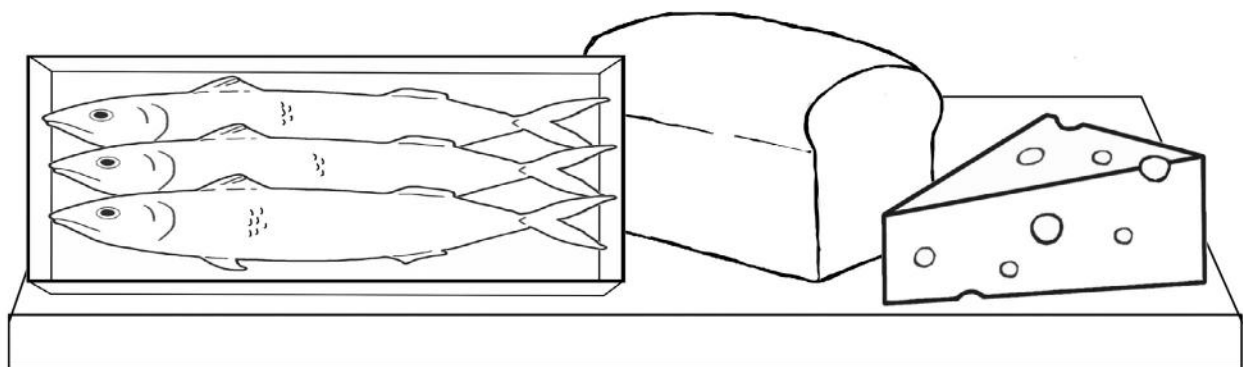
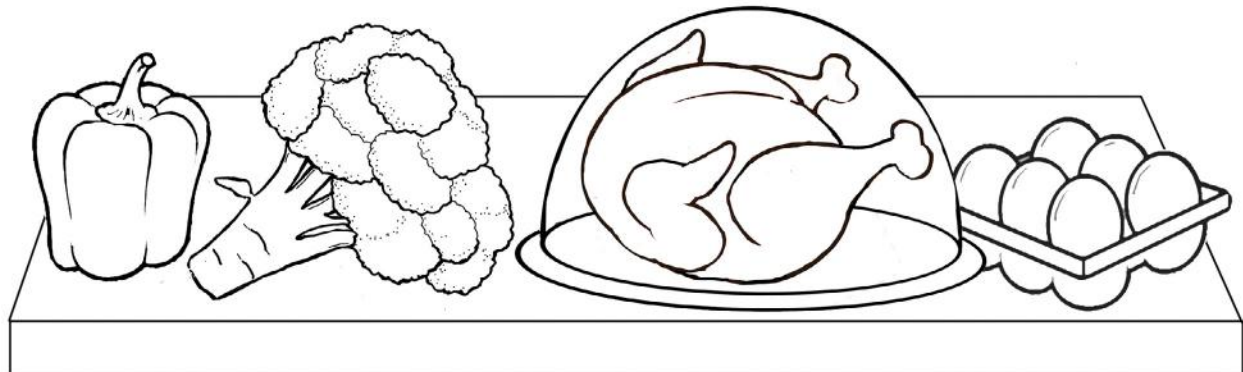
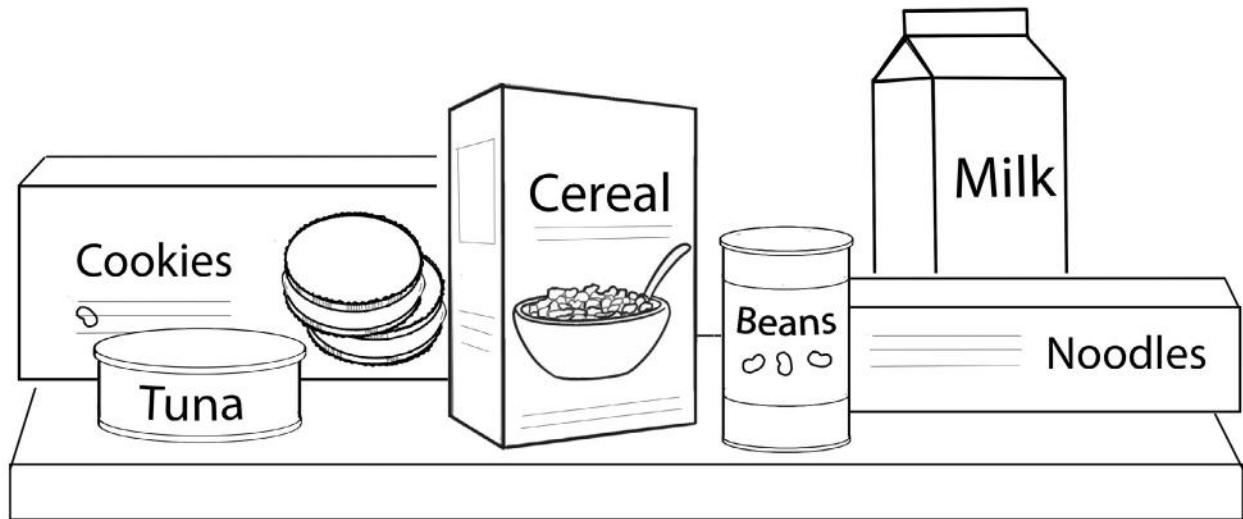

# ¿Dónde está la planta?

## PARA COLOREAR

Colorea todos los productos alimenticios que tienen ingredientes provenientes de plantas.

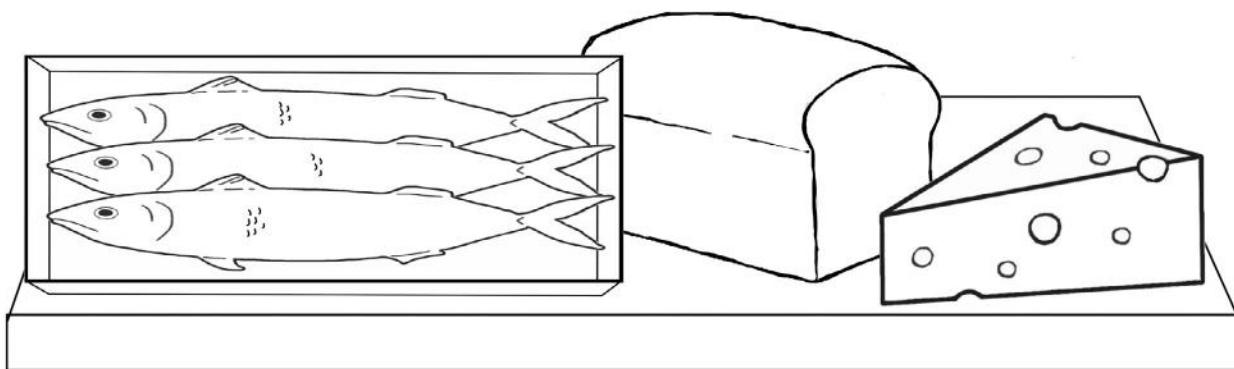
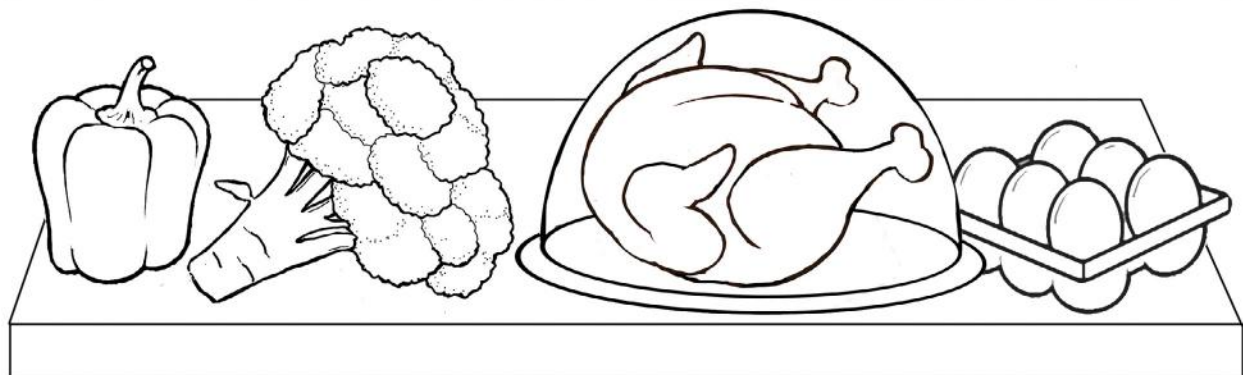
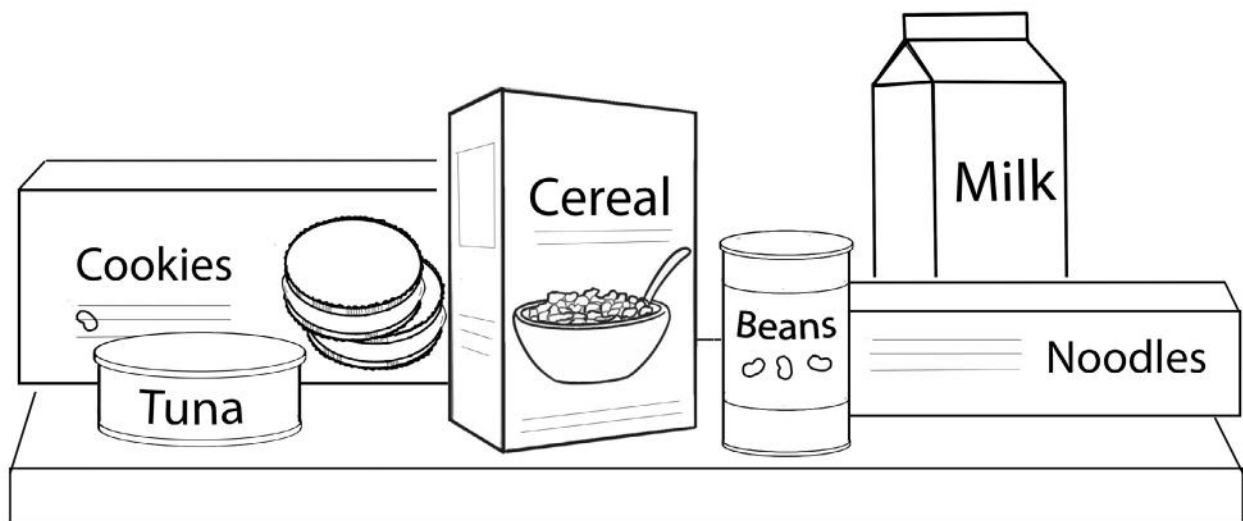

# Hydroponic Vs. Soil Taste Test

## WORKSHEET

**Food Items:** \_\_\_\_\_

*Use your senses to compare:*

### **Look:**

Does the hydroponic produce look different than the soil-grown produce?

### **Smell:**

Does the hydroponic produce smell different than the soil-grown produce?

### **Feel:**

Does the hydroponic produce feel different than the soil-grown produce?

### **Taste:**

Does the hydroponic produce taste different than the soil-grown produce?

Which was your favorite? Why?

# Prueba de Sabor Suelo vs. Hidropónico

## HOJA DE TRABAJO

**Alimentos:** \_\_\_\_\_

*Usa tus sentidos para comparar:*

**Mira:**

¿Los productos hidropónicos se ven diferentes a los productos cultivados en la tierra o el suelo?

**Huele:**

¿El producto hidropónico huele diferente al producto cultivado en suelo?

**Siente:**

¿Los productos hidropónicos se sienten diferentes a los productos cultivados en el suelo?

**Prueba:**

¿El cultivo hidropónico tiene un sabor diferente al de los productos cultivados en el suelo?

¿Cuál fue tu favorito? ¿Por qué?

# LESSON 5

## Water Versus Soil: A Hydroponic Investigation

### Guiding Questions

What are some of the challenges facing farmers today? How might hydroponic growing methods help support our food system?

### Materials

#### Laying the Ground Work:

- Internet access
- Eat a Rainbow Activity Book
- Crayons, markers, or colored pencils, or
- Seed catalogs, cooking magazines, and grocery store ads (optional)
- Glue (optional)
- Scissors (optional)
- A rainbow of fruits and vegetables to try (optional)

#### Exploration:

- Internet access
- Dry erase board
- Dry erase markers (in red, orange, yellow, green, blue, and purple if possible)

#### Making Connections:

- Blank drawing paper or graph paper
- Crayons, markers, or colored pencils

#### Extension (Optional):

- Chart paper
- Markers

### Time

**Laying the Groundwork:** 30 minutes

**Exploration:** 60 minutes

**Making Connections:** 60 minutes

**Extension:** 45 minutes

### Lesson Summary

To meet demands of a growing population, urbanization, and other societal and environmental challenges, food producers are reimagining how we can grow our food. The establishment of hydroponic production facilities is one of the many options being explored as a way to create a more sustainable, locally-based food system.

### Learning Outcomes

After completing this lesson, students will:

- Understand that fruits and vegetables are part of a healthy diet.
- Learn about the many challenges facing our food system.
- Explore hydroponic growing systems as a possible solution for increasing the production and availability of locally grown produce.

## Background Information

Eat a rainbow! There is an ever-growing body of research showing just how important consuming fruits and vegetables is to our health. In addition to providing the essential vitamins, minerals, and fiber that keep our bodies working, fruits and vegetables are also linked to health prevention benefits including decreased risk of stroke, cancer, and heart disease; improved memory; and lowered blood sugar levels. Many of these benefits are attributed to phytonutrients (also known as phytochemicals) – substances in plants that are not recognized as vitamins or minerals, but provide a definite health boost. Many of these phytonutrients are also the pigments responsible for the diversity of colors of fruits and vegetables too. So, nutrition educators have been hard at work encouraging people to fill their plates with a rainbow of fruits and vegetables to make sure they are reaping the most health benefits.

Unfortunately, accessing these recommended fruits and vegetables is not an easy task for all. Most farms are located in rural locations and centralized in certain parts of the country. To get to consumers, fresh fruits and vegetables are often picked early, before they are ripe, and travel great distances to their final destinations, such as grocery stores, supermarkets, and restaurants. Additionally, there are some communities across the country where residents lack access to places to buy fresh fruits and vegetables. Obstacles include:

- Distance to grocery stores that carry a variety of fresh produce
- Access to transportation options
- The high cost of many fresh fruits and vegetables

These obstacles affect lower-income communities (both urban and rural) and people of color in disproportionate numbers. The inequality in access to fresh, culturally relevant fruits and vegetables is fueling a movement to increase locally sourced produce at reasonable prices to ensure that all people can afford to eat well.

Human nutrition is not the only motivation for reimagining our food system. Environmental concerns, from water conservation to increased carbon in the atmosphere to awareness of the damaging impacts of pesticide use, are also coming into the spotlight and fueling the need to find alternatives to some traditional farming methods. Farmers are looking for ways to decrease water and pesticide needs while also increasing production to meet the demands of a growing population. Hydroponic growing techniques are one of the many practices being investigated to meet these challenges.

Although many people think of hydroponics as a new technology, references to growing plants without soil have been documented for hundreds of years. Hydroponics, in its simplest form, is growing plants by supplying all necessary nutrients in the plants'

water supply rather than through the soil. The development of hydroponics is rooted in practical application and the need for creating alternative growing solutions to tackle environmental and societal challenges. Although many techniques fall under the hydroponic umbrella, here are some general benefits of hydroponic growing:

- They can be used in locations where high-quality soil is not available. From concrete-paved urban areas to sand-covered deserts, hydroponic farms create growing space in inhospitable environments.
- They can be placed in urban locations close to population centers so that food does not need to travel far from harvest to market. This can decrease transportation costs and environmental impacts and also offer consumers fresher produce.
- They are free from seasonal constraints. Systems can be set up outdoors or indoors. Indoor systems allow growers more control over the plants' environment, including light availability and temperature, which allows growers more flexibility in timing of planting and harvesting of crops.
- They can be designed in different sizes depending on the space available. Gardens can be stacked on top of each other and/or located in multi-floor buildings to take advantage of vertical space and decrease the land footprint needed for a sizable production rate.
- They allow growers more control over nutrient availability. In hydroponic systems, nutrients are added to water and then provided direct access to plant roots. In soil, roots must search for the nutrients stored in the soil and there are many more organic, inorganic, and weather-related factors determining nutrient availability.
- They can maximize the growth rate of plants. Because plants are being provided with optimal amounts of nutrients, water, and light, they can grow faster than crops grown using traditional horticultural techniques, resulting in increased production rates (efficient input-to-output ratio).
- They can be designed to conserve water. Excess water can be recaptured and reused, allowing for a more efficient use of this precious resource. In most cases, hydroponically grown crops require less water than traditionally grown crops.
- They offer better control over weeds, insects, and disease. Unlike soil, hydroponic systems can be thoroughly cleaned to remove potential plant pests. This can make it easier to grow crops without herbicides and pesticides.
- They can decrease the amount of cleaning harvested crops need before consumption. This can save time, labor, and water.
- Beyond larger farm production, hydroponic systems are available for homes and schools to increase production of fruits and vegetables.



Although there are many benefits, hydroponic farming is not without its challenges. Some of those challenges include:

- Currently there are very few crops that have been cultivated to thrive in hydroponic conditions. Edible crops commonly grown hydroponically include lettuce and other greens, herbs (especially basil), peppers, tomatoes, cucumbers, and strawberries. For the use of hydroponic farming to increase, scientists must work to identify existing or develop new plant varieties that will grow well hydroponically. New hydroponic system designs may also help increase the number of crops that can be grown successfully using hydroponic techniques.
- Most hydroponic farms are very reliant on a secure source of electricity both to maintain temperature and to provide water and air to plant roots. Under normal conditions, weather may not be a factor for hydroponic crops; however, extreme weather conditions like a blizzard or hurricane that impacts energy sources can also impact hydroponic farms. (Most farms will likely have fossil fuel-powered back up generators to be able to cover short-term loss of electricity.)
- Cost is another big challenge to hydroponic production. In most cases, hydroponic farming operations are still more expensive than traditional farms, even when factoring in their associated transportation costs. The cost comparison between the two methods could change as land availability decreases and if transportation costs increase. Cost is a driving force in the supply and demand process, so even though there may be environmental benefits, until the cost of hydroponic production is closer to the cost of traditional production, it will struggle to gain a larger portion of the market.

As world populations grow and agricultural crops are impacted by environmental concerns such as climate change and water shortages, the security of our food supply will continue to be a major issue in the 21st century. Currently food resources are not equally distributed and there are inequities by geographic location and income. This gap is projected to widen as the cost of food increases due to rising demand and shrinking supplies. Alternatives to traditional farming practices such as hydroponic operations will definitely be part of the discussion as scientists and farmers begin looking for solutions to our food supply needs.

## Laying the Groundwork

Read a book or watch a video about eating a rainbow. Some options include:

### **Books:**

*Rainbow Stew* by Cathryn Falwell

*Can You Eat a Rainbow?* by Anastasia Suen

*The Rainbow Bunch* by Kia Robertson

## Videos:

### H-E-B: Eat The Rainbow with Bruce and Charlotte

<https://www.youtube.com/watch?v=-iFrSKNyvfU>

### Eat the Rainbow! Nutrition Lesson for Kids from The Physicians Committee

<https://www.youtube.com/watch?v=L1StpMfMwXY>

### FIT KIDS 23 Vitamins, Minerals, Nutrients Oh My from KSPS Public TV:

[https://www.youtube.com/watch?v=0IKrRlrvk&feature=emb\\_logo](https://www.youtube.com/watch?v=0IKrRlrvk&feature=emb_logo)

Talk about how fruits and vegetables contain many important nutrients that we need to eat every day to stay healthy and grow strong. Divide the class into 4 or 8 groups and give each group a piece of paper with a different color written or represented on it (red, orange, yellow, green, and blue/purple). Have them write down or draw pictures of all the fruits and vegetables they can think of that come in their color. If you think they might need a little inspiration, you can also hand out a seed catalog to each group to look through. When they finish, let each group share their list and then create your own classroom rainbow by writing out their ideas on the board in each of the different colors of the rainbow. Alternatively, you could use the seed catalogs to cut out photos and visually make your own classroom rainbow.

After the group activity, have students read through and complete the “Eat a Rainbow” Activity Booklet. On each page, ask them to draw pictures of fruits and vegetables that represent the different colors. If you have access to extra seed catalogs, old magazines, or newspaper grocery store ads, instead of drawing pictures, they could also cut out pictures and paste them into their activity book.

## Extend the Activity:

If resources allow, you can extend this activity with a classroom eat a rainbow taste testing activity. Encourage kids to make an edible rainbow on their plate by preparing a colorful selection of cut fruits and vegetables for them to choose from. Make sure they add at least one item from each color group to their plate. Examples to choose from include:

**Red:** beets, cherries, radishes, raspberries, red apples, red peppers, strawberries, tomatoes, watermelon

**Yellow/orange:** cantaloupe, carrots, corn, grapefruit, oranges, peaches, pineapple, yellow pears, yellow pepper

**Green:** avocados, broccoli, celery, cucumbers, green apples, green beans, green grapes, green pears, green peppers, honeydew, kiwi, lettuce, pears, peas, spinach

**Blue/Purple:** blackberries, blueberries, plums, purple cabbage, purple grapes, raisins

**White:** bananas, cauliflower, dates, jicama, turnips, white corn, white peaches

To add to their appeal and nutritional value, you may want to garnish with yogurt or vegetable dip.

## Exploration

① After students have explored the importance of fruits and vegetables, encourage them to think about where our fruits and vegetables come from. You can ask inquiry-sparking questions such as: “Where do we get our fruits and vegetables from? Who grows them? How do they get to us? Can you grow fruits and vegetables anywhere? Can you think of some places where it would be hard to grow fruits and vegetables?” If they need some prompting ask, “What about in cities? What about where it is cold? What about places where there is not much water?”

End with the question, “What if there are no grocery stores or farmer’s markets close to our home or school? What could we do?”

② Constructing hydroponic farms are one solution farmers are looking at to try and grow more fruits and vegetables in challenging locations. Watch one more of the following videos featuring some hydroponic farming facilities:

**Farm to School - San Diego Unified School District Harvest of the Month - Organic Bloomsdale Spinach (2:47 minutes)**

[https://www.youtube.com/watch?v=dA6NW\\_s6XKc](https://www.youtube.com/watch?v=dA6NW_s6XKc)

**CBS This Morning: How Aerofarms’ vertical farms grow produce (5:10 minutes)**

[https://www.youtube.com/watch?v=ME\\_rprRImMM](https://www.youtube.com/watch?v=ME_rprRImMM)

**Vertical Roots Farm: Gardening in Repurposed Shipping Containers (8:01 minutes)**

<https://www.youtube.com/watch?v=jKY60Orcwic>

**PBS News Hour: Could indoor farming help address food shortages? (9:36 minutes)**

<https://www.youtube.com/watch?v=7J9f59usLfI>

**State Fair of Texas – Big Text Urban Farm Tours:**

<https://bigtex.com/tour-the-big-tex-urban-farms/>

Based on these videos and/or their firsthand experience if you started the growing experiment in Lesson 1, ask students to brainstorm benefits of growing plants in hydroponic systems. You can use details from the Background Information to help come up with ideas if needed. Make sure your discussion covers the following points:

- Hydroponics can help people grow food locally and in spaces that are all different sizes.
- Hydroponic growing systems can produce crops year-round no matter what the weather is like.
- Hydroponics can help gardeners and farmers use resources like water more efficiently.

## Making Connections

---

Based on all they have learned about hydroponics, ask students to think about whether they think a hydroponic growing system or farm would be a good thing for your classroom, your school, homes, or your community? Why would it be beneficial? What would you want to grow?

Ask students to select a real location in their lives that they think would be a great location for a hydroponic growing system. They can pick a place at school (maybe the cafeteria), at home, at a local library, in a school bus, or any place they think would work. Next, ask them to design their own system. Also ask them to specify what kind of plants they would grow. (They can be real or they can dream up a brand new plant species, too). Remind them of all the things plants need (light, air, water, nutrients, and space to grow) and ask them to incorporate those into their drawing and plan.

Showcase their ideas in a Hydroponic Expo to celebrate the completion of this unit on hydroponics.

### **Extend the Activity:**

If you would like to dig deeper into engineering and design, challenge students to design and build their own hydroponic systems out of repurposed common household items.

## Extension (Optional)

If you started a hydroponic versus soil-based garden experiment in Lesson 1 Extension, compile the data collected into a class table and chart. Which plants grew faster? What plants looked healthier? If you have not done so already, set up a taste test to compare your harvest. Is there a difference in taste based on the growing method used?

Divide students into small groups and ask them to create a news report to share with others about their experiment. Ask them to include information that answers these 5 questions:

- What is hydroponics?
- Why do people grow plants using hydroponics?
- What did we do for our experiment?
- What did we learn from our experiment?
- Based on our experiment, should other people try growing plants using hydroponics?

Have them write a script for their news report and then, if possible, have each group create a video of their report and share it with other classes and families.

If you did not start the experiment in Lesson 1, you can use the videos referenced in the Exploration to answer slightly revised versions of the questions above:

- What hydroponic techniques are spotlighted in this video?
- Why are the people in this video using hydroponic techniques?
- What benefits of hydroponic gardens are provided in this video?
- How could you use the information in this video to explain to others why they should use hydroponic gardens?

# Eat a Rainbow

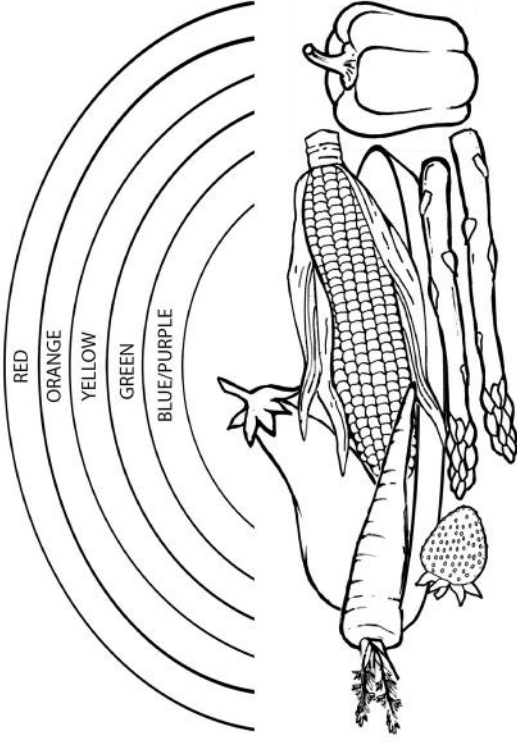

**I eat red fruits and vegetables.**

**Draw pictures of your favorite red  
fruits and vegetables.**

**I eat blue and purple fruits  
and vegetables.**

**Draw pictures of your favorite blue and purple  
fruits and vegetables.**

**I eat orange fruits and vegetables.**

**Draw pictures of your favorite orange  
fruits and vegetables.**



**I eat yellow fruits and vegetables.**

**Draw pictures of your favorite yellow fruits and vegetables.**

**I eat green fruits and vegetables.**

**Draw pictures of your favorite green fruits and vegetables.**

# Come un Arcoíris

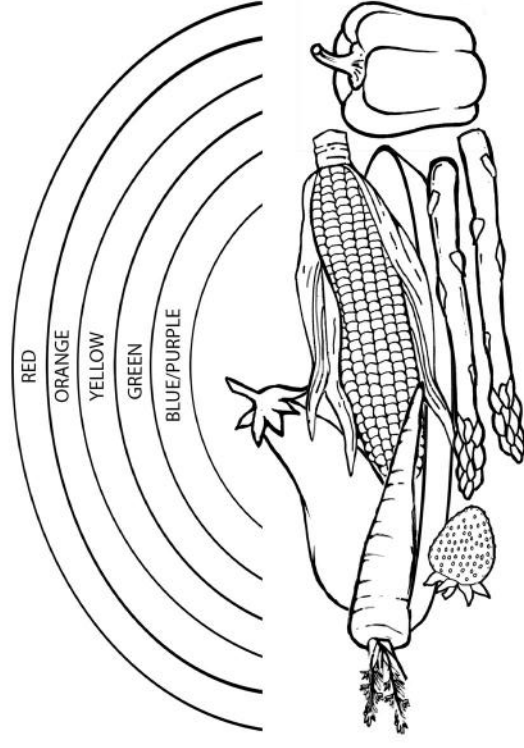

**Yo como frutas y verduras rojas.**

**Haz dibujos de tus frutas y verduras rojas favoritas.**

**Yo como frutas y verduras de color azul y morado.**

**Yo como frutas y verduras de color naranja.**

**Haz dibujos de tus frutas y verduras favoritas de color azul y morado.**

**Haz dibujos de tus frutas y verduras anaranjadas favoritas.**

**Yo como frutas y verduras amarillas.**

**Haz dibujos de tus frutas y verduras  
amarillas favoritas.**

**Yo como frutas y verduras verdes.**

**Haz dibujos de tus frutas y verduras  
verdes favoritas.**

# APPENDIX A

## Hydroponic Basics

### Introduction

Hydroponics, in its simplest form, is growing plants by supplying all necessary nutrients in the plants' water supply rather than through the soil. The word derives from the Greek root words "hydro" and "ponics," meaning water working. Growing plants hydroponically helps gardeners and farmers grow more food more rapidly in smaller areas (greenhouses, living rooms, classrooms, and rooftops, for instance) and to produce food in parts of the world where space, good soil, and/or water are limited. In hydroponics, water with dissolved nutrients is applied as a bath, periodically irrigated through the growing medium, or sometimes sprayed directly on the roots. The following information is designed to provide you an overview of growing plants using hydroponic techniques.

### Meeting Plant Needs

Plants, like all living things, have certain requirements that need to be met for them to grow and thrive. These include water, nutrients, light, air, and structural support for the roots. In traditional gardening, plants get root support, nutrients, water, and oxygen from the soil. Without soil, hydroponic growers must find ways to provide water and the right balance of nutrients directly to the plants' roots, enabling the plants to concentrate their energy on producing leaves and fruits rather than searching for water and nutrients. Another challenge is designing ways of providing the support and oxygen that plants need. Before reading more about plant needs and some of the innovative ways hydroponic gardeners meet them, read this refresher on plant plumbing.

### Roots and Shoots

The most important function of plant roots is to absorb water and nutrients. How does it happen? Covering the growing tip of each root are hundreds of tiny root hairs. The cell walls and membranes of the hairs are porous, thereby allowing water containing dissolved minerals nutrients to enter. The movement of the molecules through the cell membranes is called osmosis. Osmosis occurs because the water seeks balance in the concentration of nutrients inside and outside of the plant.

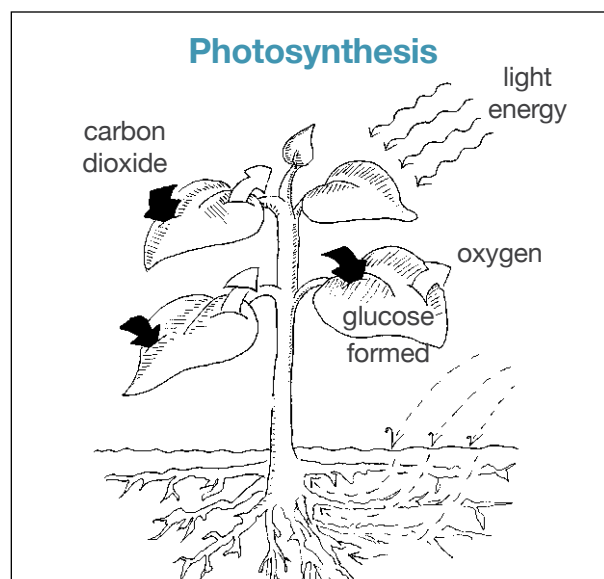

Plant roots deliver the necessary water and nutrients (via the stem) to the plant's leaves where photosynthesis – carbohydrate production – occurs. During photosynthesis carbon dioxide enters the plant through the leaf's surface. Carbohydrates (glucose) are produced from carbon dioxide and a source of hydrogen (water) in chlorophyll-containing plant cells when they are exposed to light. This process results in the release of oxygen. These carbohydrates fuel plant growth and reproduction. Only a small amount of the water sent to the leaves is used in photosynthesis; the rest is given off into the air through transpiration.

## Water

Did you know that most plants are composed of about 90 percent water? It's an essential component of photosynthesis, necessary for normal cell function, and is the medium in which nutrients are transported throughout the plant. Plants need water in different amounts during different growth stages. A large cucumber plant, when fruiting, can use up to a gallon of water a day! As stated above, transpiration uses up the majority of a plant's water intake.

## Nutrients

Whichever type of hydroponic system you select or create, you must supply the plants with nutrients. In soil, these elements come from rock and mineral leaching and organic matter decomposition. They are "held" by the soil particles and dissolved in the surrounding water. In hydroponics, the liquid solution is taken in directly by the roots and provides the leaves with nutrients through the transportation system in the stem. These nutrients or minerals are not actual food, but elements vital to helping the plant utilize the sugars (the real food) that it produces during photosynthesis.

**Important Nutrients:** Plants need about 16 different essential elements for optimum growth. Macronutrients, which are ordinarily found in soil, are needed by plants in rather large amounts. (Hydrogen, oxygen, and carbon are also necessary in large amounts, but are available to plants from the air and water.) The following are essential macronutrients and some of their most important functions in plants:

- nitrogen (N)–Promotes development of leaves
- phosphorus (P)–Aids in growth of roots
- potassium (K)–Helps plant resist disease
- calcium (Ca)–Helps promote new root and shoot growth
- magnesium (Mg)–Contributes to leaf color and helps absorb sunlight
- sulfur (S)–Contributes leaf color

Trace elements, or micronutrients, including manganese, iron, copper, and others, are important to the total well-being of the plant, but are needed in much smaller amounts.

Hydroponic gardeners must provide plant roots with a nutrient solution containing an appropriate balance of necessary nutrients. The easiest way to supply them is to purchase prepared hydroponic nutrients in dried or liquid form. Most are concentrated and must be mixed with water.

**Mixing Solutions:** When mixing nutrient solutions, always dilute them to the concentration recommended by the manufacturer. Water between 65 and 75 degrees F makes nutrients most available to plants. Tap water may contain significant concentrations of chlorine, which can adversely affect plant growth. If your water has a lot of chlorine, you can use distilled water or simply let water stand uncovered for a couple of days before using it.

**How Much to Use:** The amount of nutrient solution you use depends on the type of system, temperature, light, and other factors. If you're growing plants like lettuce, herbs, or flowers in a simple system such as a floating raft, a good rule of thumb is to provide 2 quarts of nutrient solution per plant. If you're trying to raise larger, fruiting crops in a more sophisticated system, you'll need to supply closer to 2 gallons of nutrient solution per plant.

**Maintaining Nutrients:** You'll have to replace the nutrient solution at different intervals depending on the type of system you set up, because nutrient concentration will vary as nutrients are taken up by the plant and as water evaporates and transpires from plant leaves. Commercial growers use special equipment to measure the concentration of nutrients in a solution. A good general rule for most classroom and/or home systems is to replace the mixture with a fresh batch every 10 to 21 days. As the water in your system evaporates and transpires, you may also want to top off the solution with more water to avoid building up concentrations of mineral salts.

**Nutrient Disposal Caution:** Take care where you dispose of nutrient solutions. Houseplants, indoor plants, and container gardens are fine places to recycle the liquid. However, aquatic ecosystems are quite sensitive and the balance of minerals is very delicate. If there is a stream, lake, or other water source nearby, do not dispose of liquid nutrients on the ground.

**pH: The Acid Test:** The pH of the nutrient solution is an important factor in hydroponics. It is a measure of the acidity and alkalinity on a scale from 1 to 14, with 1 being very acidic, 7 being neutral, and 14 being very alkaline. Most of the plants in your classroom hydroponics projects grow best when the pH of the nutrient mix is between 5.8 and



6.5. At pH readings above or below this range, certain nutrients become unavailable to plant roots. The range that allows the plant to use the dissolved minerals (nutrients) most effectively is just slightly acidic. pH levels vary in different nutrient mixes and water sources. If you change your nutrient solution every 10 to 21 days, as suggested, you needn't be concerned with adjusting pH.

To determine pH of your solution, you can use narrow-range pH paper, reagent type test kits, or a pH meter to do so. These can be found through many online retailers and aquarium suppliers or science supply catalogs. Simple ways to change the pH: drops of white vinegar can lower the pH while baking soda can raise it. Hydroponic suppliers offer other products for adjusting pH.

## Mixed Media

The material that a plant lives in or on is called its medium or substrate. For most plants, the medium is soil. Hydroponic growers find other ways to support growth to prevent drowning plants. Many setups use an inert, sterile medium. Some of the more popular choices included gravel, clean sand, perlite(volcanic material that is heated until it expands into a lightweight, styrofoam-like material), a lightweight pebble-like aggregate, and rockwool (an inorganic, spongy, fibrous substance that holds large amounts of water and air). These materials provide passages among the particles or fibers where air and water can circulate.

Each medium has strengths and weaknesses. Gravel and sand, for instance, provide support and good drainage, but can be heavy when wet and will dry out fast. Perlite is light and holds water well, but its fine dust can irritate lungs. (Sprinkle it lightly with water to avoid this.) Rockwool holds water and air nicely and makes it easy to move plants around, but breaks down fairly quickly.

Some hydroponics systems have no real media, but more or less elaborate ways of suspending plants in nutrient solutions. In commercial nutrient film technique (NFT) and aeroponics, for instance, the roots lie or are suspended in a dark channel and nutrients are sprayed or trickled along the root zone.

## Oxygen

**Getting Oxygen to the Roots:** Even roots buried in soil must have oxygen for the plant to survive. Plants respire by taking in oxygen, which triggers plant cells to release and use the energy manufactured during photosynthesis, while also releasing carbon dioxide and water. Plant roots typically take in oxygen that's available in the small spaces between soil particles.

In short-term passive hydroponic systems, there are other means of getting oxygen to the roots. In some setups, water and nutrients reach the roots via a wick made of absorbent material, and part of the roots are continually exposed to air. A porous medium like rockwool has a tremendous capacity for retaining oxygen while also absorbing nutrient solution. Greens such as lettuce and herbs seem to be the best bets for a minimally aerated environment.

Many hydroponic systems use a pump to infuse oxygen into the water. For small setups, aquarium pumps and tubing do the trick. In larger systems (particularly commercial ones), the medium and roots are periodically splashed or flooded with a nutrient solution, allowing oxygen to bathe the roots in the interim.

In systems using aquarium pumps and tubing, an optional attachment to the end of the tubing placed in the water is an air stone. Air stones are made of porous material and are designed to help disperse the air into smaller bubbles. They are used to improve water circulation, keep the tubing in place and may also decrease the noise produced by the system.

## Light

All green plants require light to drive the process of photosynthesis. The higher the light level, the potentially larger your hydroponic harvest, as long as you're adequately meeting other basic needs. If your plants are getting leggy (thin stems and small leaves) or not growing, the light source is the first factor to check. Keep a close eye on how your plants are responding to light and adjust exposure accordingly.

**Natural Light:** The sun radiates the full spectrum of light essential to plant life. A greenhouse is great for growing hydroponically. A sunny windowsill will suffice for many non-fruiting vegetables, herbs, and flowers if you place your hydroponic unit 1 or 2 feet away from the glass. In climates with a lot of sunlight, make sure your plants get at least four hours per day of shade.

**Artificial Light:** Fluorescent and LED lights hung from shelves or other setups will suffice for certain crops if kept on 14 to 16 hours per day. While many houseplants and smaller plants with low light requirements (e.g., seedlings, lettuce, or herbs) will thrive in a hydroponics setup under basic fluorescent lights, commercial hydroponic gardeners and home gardeners wanting to grow larger fruiting and flowering light-loving crops (e.g., tomatoes) to maturity often use special high-intensity lights designed to provide bright, efficient light closely approximating sunlight.

## Planting Advice

You will raise most of the plants for your hydroponic garden from seed, but you can start houseplants and many herbs from cuttings of mature plants. If you have a simple system without pumps or other forms of aeration, your best bets are the following:

- lettuce
- herbs (particularly basil)
- beans
- houseplants
- annual flowers such as marigolds, zinnias, nasturtiums

If you have a more sophisticated active or commercial system, you might also try these crops:

- tomatoes
- cucumbers
- bell peppers
- corn (in tubes)

### Growing From Seed

You can start seeds in cotton, cubes of rockwool, peat plugs, perlite, or sand. After planting seeds, check regularly to make sure seeds remain moist, but are not water logged or moldy. If they are too wet, there may not be enough air for seeds to germinate properly. Some seeds, like beans and corn, will germinate in just a few days. Some others, such as tomato, bell pepper, and herbs may take as long as two weeks until they appear. If you do not see any sign of life after two weeks, it is best to replant the seeds.

#### Rockwool Cube

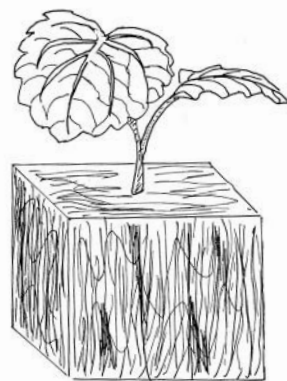

After the true leaves form (the first one or two leaves to appear are the cotyledons or seed leaves) and a seedling is from one to several inches tall, you can transplant it into your system. Transplanting a seedling can be very stressful for a plant. Gently and carefully remove the plant, taking care not to damage the roots. A seedling, when transplanted into a bigger growing unit, is stressed at first. Some hydroponic gardeners recommend starting with half-strength nutrient solution, or initially spraying the leaves with nutrient solution rather than spraying or submerging roots, to minimize stress.

## Growing From Cuttings

Houseplants such as coleus, tradescantia, heartleaf philodendron, pothos, and geranium grow quite well from cuttings. Rockwool cubes soaked in a 25 percent nutrient solution are nice for starting cuttings. You can also use moist perlite or sand. Cuttings root more quickly if they're covered with a plastic dome or misted regularly to maintain a humid environment.

## Plant Care Tips

As with plants grown in soil, your hydroponic unit seedlings and cuttings require ongoing care. Here are a few general suggestions:

- Plan space accordingly. Leafy and vining plants need room to spread out; provide support or trellising for such plants as tomatoes and cucumbers.
- Grow disease- and pest-resistant plant varieties. (Good growing practices should minimize disease and pest problems.)
- Practice good hygiene. (Without soil to filter contaminants, the liquid solution can transport impurities.) Wash hands before and after working with plants. Start with clean containers (a cleaning solution of 1 part bleach to 9 parts water is recommended).
- Observe plants carefully for signs of insect pests. Aphids, spider mites, and white flies go for lush growth. Either hand-pick pests, wash plants gently with a mild soap solution, or remove infested plants from the setup.
- Change the nutrient solution regularly. Depending on the type of system you're using, you should change the nutrients every 1 to 3 weeks or so. Try to keep the pH between 5.8 and 6.5, the water temperature at around 70 F, and the reservoir full.
- Plan ahead for vacations. If the setups are small enough, you might be able to send hydroponic gardens home with students. If your unit is large and has an automatic aeration/circulation pump, it can be left running, but be sure to let someone know it is on. Make sure the nutrient solution container is filled before you leave, and that automatic lights are correctly working on a timer. Some schools plan hydroponics projects to coincide with semesters or terms, to avoid the problem altogether.

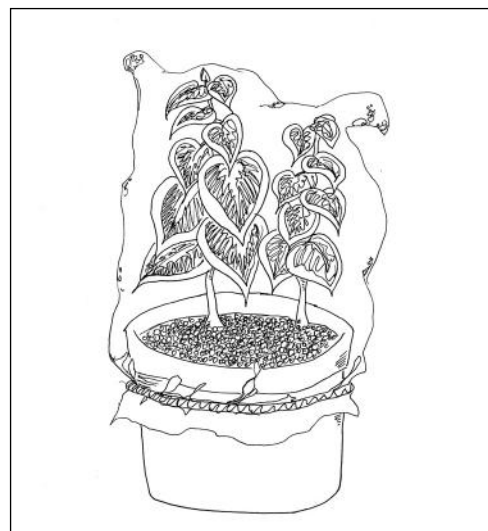

# APPENDIX B

## Hydroponic Systems Guide

Hydroponic systems are broadly divided into two different categories: passive and active. Both active and passive systems can then be defined as being media-based or water-culture.

### Passive Systems

These systems use no energy to move nutrients and water. Passive systems often use a “wicking” material to draw up the liquid nutrients for the roots to access, or they simply suspend the plants in the solution with an air space around some of the root zone. They can also be as basic as a perlite-filled flowerpot that is hand-watered regularly with nutrient solution.

### Active Systems

A hydroponic system is active if it relies on some type of energy (usually electricity via a pump) to move the nutrients in and out of the root zone area and to provide aeration. These systems are generally used for larger plants (e.g., tomatoes and cucumbers) and tend to be more sophisticated. In recirculating or recycling systems, the nutrient solution is conserved by being recirculated either manually or electrically through the medium. These systems require closer monitoring of pH and nutrient concentrations. Systems with pumps to aerate and deliver more oxygen to roots tend to produce healthier plants more quickly than do passive systems.

### Media-Based Systems

These types of hydroponic systems rely on some material, such as gravel, aggregate, perlite, vermiculite, or rockwool to support the plants and the roots in the nutrient solution. Such systems can be active or passive and may or may not recycle the nutrients.

### Water-Culture Systems

These systems do not use any medium other than water, so they require a support material such as wire mesh to keep the plants from drowning. These systems rely on regular contact between plant roots and the nutrient solution. Leafy crops like lettuce and herbs tend to do better in water culture than do fruiting crops like tomatoes, cucumbers, or peppers.

The following pages offer diagrams and description of common hydroponic systems.

## Media-Based Systems

Following are descriptions of some common types of media-based systems.

### Wick Systems (passive)

- Very simple
- Passive
- Plants grow in a container filled with growing media that is placed in a larger container full of a nutrient solution
- Nutrient solution travels from a reservoir up a nylon or cotton wick to the plant roots

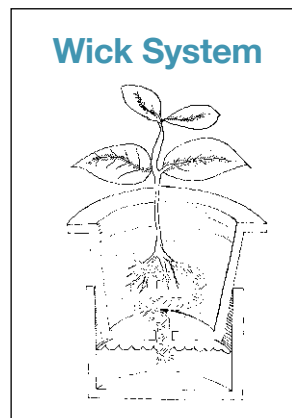

### Ebb and Flow Systems (active)

- Active system
- A container full of plants and growing medium is placed at an angle with a drain at the lower end of the container
- The container is flooded up to 6 times a day with nutrient solution (by hand or using an automatic system)
- As water drains out of the container, it will draw in air into the medium
- Drained water can be captured and reused
- Every several cycles, must use a water rinse instead of nutrient solution to remove any built-up, crusted salts.

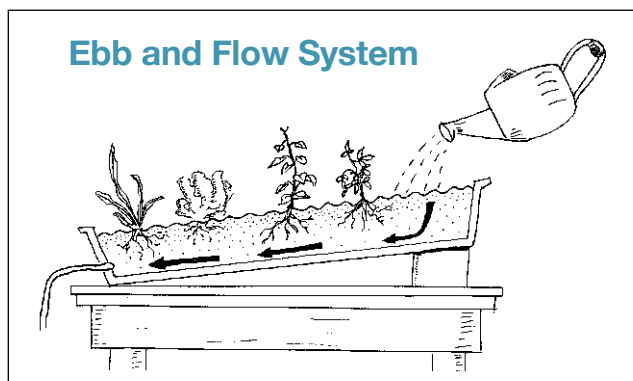

### Top-Feed or Drip Systems (active)

- Active system
- A container with plants and growing medium is placed above a tank or container full of nutrient solution
- A pump pulls water up from the bottom tank/ reservoir and moves it to pipes that then release the water into the container with the plants like a sprinkler system. The pipes with holes in them are called "emitters"
- Excess water drains through the top container back to the bottom tank/reservoir to be used again
- The pump is usually controlled by a timer

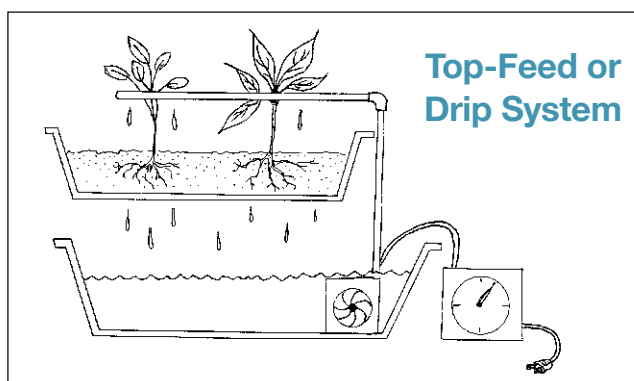

## Water-Culture Systems

### Raft System

- Can be passive or active
- Plants float on rafts above a reservoir or tank of nutrient solution
- The raft can be made from styrofoam
- The tips of the roots reach into nutrient solution
- Some air space left around holes and in the tank to allow some air for plant roots
- Can add a pump to make it active and to provide more oxygen in water for plant roots

#### Passive (no water movement)

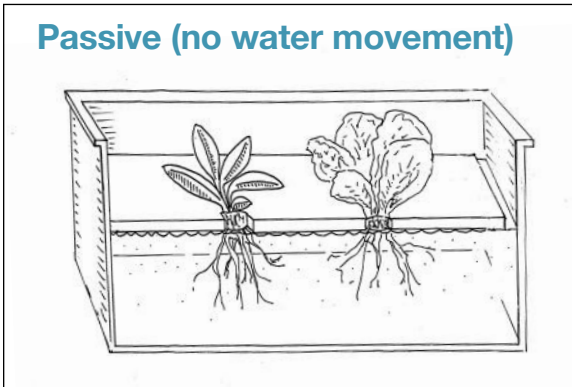

#### Active

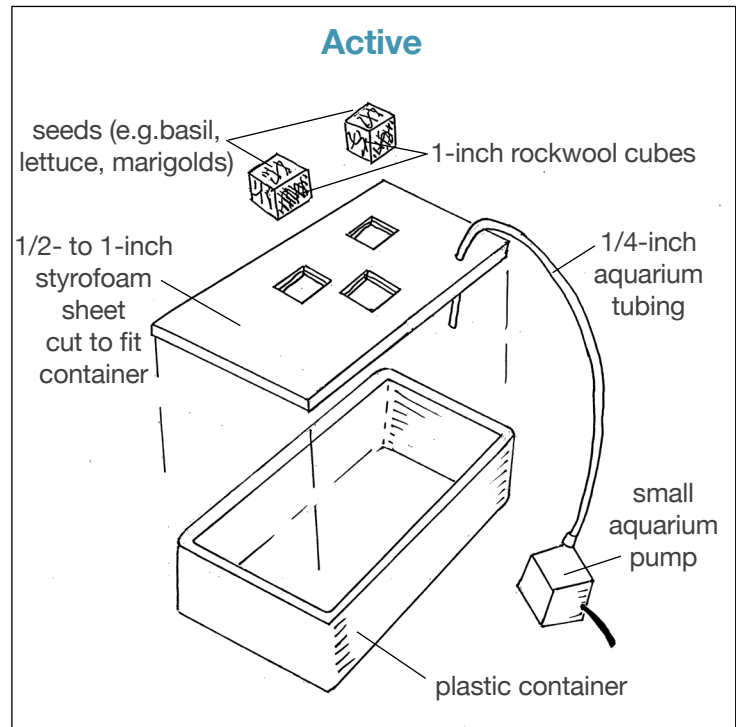

### NFT (Nutrient Film Technique)

- Active system
- Plants are suspended from holes made in a tube so the roots grow inside the tubes
- Growers may use wire or plastic nets or rockwool cubes to keep plants in place
- A pump is used to move nutrient solution from a reservoir/tank into the tubes
- As the spray moves through the tubes, it also provides air in the solution
- Nutrient solution is recaptured at the end of the tube and returned to the reservoir where it can be used again.

#### Nutrient Film Technique

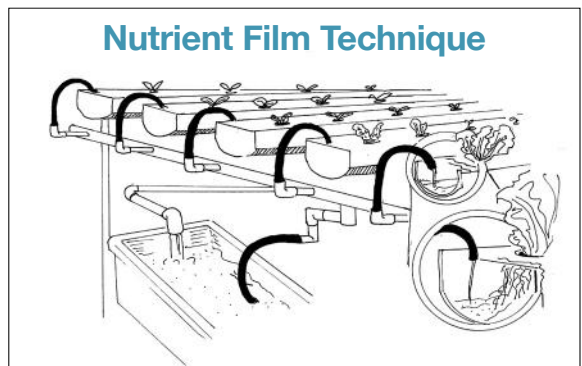

## Aeroponics Systems

- Active system
- Plants are suspended in the air, usually with roots inside a container
- The air inside the container is sprayed or misted with a nutrient solution.

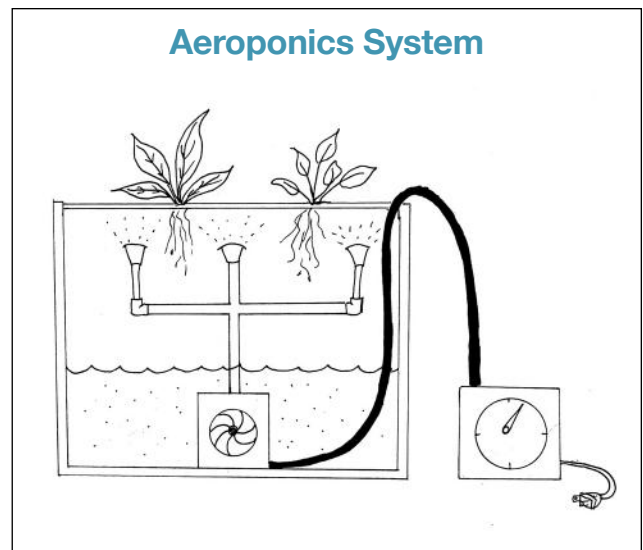



# APPENDIX C

## Steps to Starting a Hydroponic Garden Program

As mentioned in the introduction of this guide, hydroponic garden programs offer a wide variety of benefits to students and educators. Just like traditional school gardens, planning and preparation are important in order to create a successful and sustainable program. Below is an overview of recommended steps\* for creating a new hydroponic garden program along with links to additional supporting resources.

### Step 1: Gather Support

Who will you involve in your school hydroponic garden program? The answer should be, “Everyone!” Key supporters for your program should include administrators, educators, food service directors and cafeteria staff, school support staff, school neighbors, community volunteers, caregivers, and most importantly, your students. Assembling a strong group of excited supporters is as important to starting a school garden program as obtaining the basic supplies and equipment. Supporters may turn into volunteers who help with installation of the garden; they may assist behind the scenes by donating funds or supplies, or they may just serve as cheerleaders, recognizing your efforts and bolstering your motivation. Regardless of the role they play, many hands are needed to ensure a successful, sustainable garden program. Work to get supporters involved in your efforts as early in the process as possible.

**Learn More:** Gathering Support <https://kidsgardening.org/create-sustain-a-program-gathering-support/>

### Step 2: Form a Garden Committee

Although you want to attract an enthusiastic group of supporters, from that larger group you need to find a few people who are willing to roll up their sleeves and really pull the garden program together as part of a garden committee. Ideally this group would include at least one representative from each of your key player groups, including an administrator, an educator, your food service director (especially important if the goal is to feature garden produce in the cafeteria), a support staff member, a parent, a student, and a community volunteer. Having diverse membership will result in a creative group with connections to a variety of resources.

**Learn More:** Forming a Garden Committee <https://kidsgardening.org/create-sustain-a-program-forming-a-garden-committee/>

### Step 3: Determine Hydroponic Garden Program Goals

You've put together an awesome team and you are ready to organize your ideas into a design and dig in, but there is still one more very important planning step to accomplish. Your garden committee needs to compile all the ideas collected from key players and craft a set of written goals and objectives for your school garden program. Undoubtedly, you will already have a sense of what you hope the garden program will accomplish and what you want to plant. However, it is important to turn these abstract thoughts into concrete goals and objectives. Your goals will guide your design and serve as a measure for success. Having them written down helps you communicate them to others (not only to the involved key players but also potential sponsors), and it also helps you stay focused throughout the installation process.

**Learn More:** Determining Garden Program Goals <https://kidsgardening.org/create-sustain-a-program-determining-garden-program-goals/>

### Step 4: Design Your Hydroponic System

There are many different types of hydroponic system ranging greatly in size and expense. Carefully assess the resources and spaces available to you, then design a hydroponic garden that best fits your needs.

**Learn More:** Appendix B: Hydroponic Systems Guide

### Step 5: Find Funding

Begin by creating a list of supply needs and estimating the costs for the entire project. Preparing a realistic budget will provide you with a good fundraising target. Remember to include expenses for site development and improvement, routine maintenance, curriculum materials, and miscellaneous items. Additionally, before you get started, you need to create policies and procedures for handling money and donations that come in.

Next explore your fundraising options. There are a number of ways to acquire the materials and funds you will need to sustain your school garden program including:

**Solicit In-Kind Donations:** Collecting in-kind donations can be a very effective way to support your school garden program. From making personal requests through meetings and newsletters to utilizing online networking sites like Donors Choose and Next Door Neighbor, finding product donations may be easier than finding financial donations.

**Explore School Funding Sources:** Contact your school's PTO/PTA. Look for funds within the school or school district budget. If your administrators are supportive of your program and if you make sure that the garden activities are closely aligned with the required curriculum, they may be able to find district funds that can be used to meet garden needs.

**Plan a Fundraising Project:** Another way to raise funds for your garden program is by selling a product or service. You can do this using a traditional fundraising project or by starting your own school garden business.

**Reach Out to Local Corporations and Foundations:** Many corporations and foundations reserve funds specifically to donate to nonprofit and educational institutions. To find sources of educational funds available in your area, talk with your principal, subject area coordinators, or district grant writer.

**Apply for a Grant:** Grants are awards designed to provide funds or materials to support specific projects or programs. Funders typically have guidelines for award eligibility and an official application form. It pays to research the background of the granting agency or foundation so you can make sure your objectives meet its goals. You can often find this information in a grant announcement, descriptions of previously funded projects, or annual report. Keep in mind when applying for national grants, especially, that the number of applicants is usually much greater than the number of grants available.

**Learn More:** Funding a School Garden Program <https://kidsgardening.org/create-sustain-a-program-funding-a-school-garden-program/>

## Step 6: Recruit Volunteers

The garden coordinator cannot do it alone; additional volunteers are needed. There are two different categories of volunteers — ongoing volunteers and occasional volunteers. Ongoing volunteers can be called on for regular help in the garden. Look to parents, Cooperative Extension Master Gardener volunteers, neighbors, college students (pre-service teachers/graduate students), and seniors' organizations to find volunteers to fill this role. Occasional volunteers are those who can be called on to help with special events, especially large jobs such as initial construction of your hydroponic garden or clean up at the end of the harvest. By pitching in an extra hand when things are at their busiest, they also help prevent burnout of your ongoing volunteers, who may feel overwhelmed with heightened demands. In addition to the potential volunteer groups listed above, you can also reach out to Scouts (many gardens have benefited by serving as a site for an Eagle Scout project), garden clubs, service organizations, high school students, local farmers, local businesses, and local nursery staff.

**Learn More:** People Resources – Valuing Volunteers <https://kidsgardening.org/create-sustain-a-program-people-resources-valuing-volunteers/>

## Step 7: Dig In

Finally, it is time to get your hydroponic garden growing. Appendix A: Hydroponic Basics offers tips to help you set up, plant and maintain your system.

**Learn More:** Appendix A: Hydroponic Basics

## Step 8: Sustain the Program

Hydroponic gardens are a significant investment of time, energy, and resources, so you want them to last beyond one growing season! Gathering support, creating a garden committee, setting realistic goals, designing the garden and the garden program to meet these goals, obtaining necessary resources, and using gardening techniques to make maintenance as simple as possible will all contribute to the longevity of your garden. Here are some additional tips to make sure your school garden thrives over time:

- Use your garden regularly and purposefully.
- Re-evaluate goals annually.
- Recruit new committee members and volunteers.
- Add a new feature each year.
- Document and share your efforts.
- Establish measures for success.
- Thank everyone involved.
- Enjoy!

**Learn More:** Sustaining Your Garden Program <https://kidsgardening.org/create-sustain-a-program-sustaining-your-program/>

\*The following recommendations are inspired by Starting a School Garden Program Overview at: <https://kidsgardening.org/create-sustain-a-program-starting-a-school-garden-program-overview/>.

# APPENDIX D

## Using Your Hydroponic Garden Harvest

Giving kids the opportunity to grow, harvest and eat delicious and nutritious vegetables, fruits and herbs fresh from the garden is one of the many benefits of a school garden program including those grown using hydroponic growing techniques. To keep this experience positive and safe, you need to pay attention to some basic harvesting guidelines to help reduce the possibility of food-borne illnesses. This shouldn't discourage you from allowing children to enjoy all the benefits that come from gardening and eating fresh food. The following suggestions are, with a little planning, generally easy to implement. They'll help everyone involved in your garden program bring in a healthy harvest!

**Enlist healthy harvesters.** Make sure everyone harvesting edibles, both children and adults, is in good health.

**Harvest with clean hands.** Before picking edibles all harvesters should wash their hands thoroughly with soap and clean, potable water; then rinse under running water and dry with a single-use towel.

**Gather produce in clean containers.** Gather your produce into clean, easily washable, food-grade containers. If you use plastic bags to collect produce, make sure they are food-grade, and don't reuse them.

**Store produce safely.** You can store produce unwashed in clean, food-grade plastic bags and wash it right before you are ready to prepare or eat it. If you choose to wash edibles before storing, be sure to dry them thoroughly with clean paper towels before storing, as moisture will promote the growth of microbes on them. Store produce that needs refrigeration at 40° F or less.

**Wash produce correctly.** Although the harvest from your hydroponic garden will most likely look cleaner than produce harvested through a traditional garden, you still want to wash it before consuming it. Make sure that the water used for washing produce is potable (drinking water safe).

## Cooking and Tasting Activities

Whether in the cafeteria, a classroom, or an afterschool program, providing youth with the opportunity to prepare a simple snack or meal, experience new flavors and voice their opinions promotes personal growth and discovery. Kids' comfort zones and palates expand with each new food sampled. They also begin to develop a mastery of life-long culinary skills with every carrot chopped and recipe read. By creating an organizational culture that supports the process of exploring new fresh foods, you can help lay the groundwork for the next generation of engaged and healthy eaters.

Food preparation and tasting activities using garden produce can be as simple or as complex as you want, depending on the materials and time you have available. Just remember, whether you choose to simply try fresh washed greens from the garden or prepare a full meal, the most important thing is to make sure you're following standard food safety guidelines in the kitchen just as you did during harvesting. Important food safety guidelines to remember are:

**Wash hands.** Just as important as at harvest time, this is rule #1! Teach kids how to wash their hands properly and make sure they do so before handling food.

**Clean your equipment.** Before you start to prepare food, clean all work surfaces (including the sink) with hot soapy water. Also be sure your utensils and dishes are clean. Always use one cutting board for vegetables and fruits and a different one for raw meats and fish.

**Clean your produce.** It is preferable to wash produce right before eating it if possible, rather than when you store it. Wash all fruits and vegetables under running water. Scrub them with your cleaned hands or vegetable scrub brush and dry with paper towels.

## Simple Tasting Activities

The most basic eating experience is to hold a taste test using only a single ingredient. Here are some ideas to help you plan and conduct a simple tasting event:

- Sample a single whole food item from your hydroponic garden. Have youth describe as many characteristics of the food as possible, including appearance, flavor, texture and aroma—make it a full sensory experience and dig deep into descriptive vocabulary!
- To add a little more complexity to the activity, try multiple varieties of a single vegetable. You might have young gardeners taste an array of lettuce varieties, for example. Record their preferences on a table, graph, or chart, and use comparative language to describe distinctions between varieties.
- Explore the differences between a vegetable fresh from your hydroponic garden, a traditional outdoor garden and one from a grocery store. Compare where and how they were grown. Investigate how far your store-bought item traveled to get from its point of origin to your classroom.

As you conduct your taste tests, remember that food tastings should be inclusive. Create a judgment-free atmosphere where all preferences are valid. Youth should not feel pressured to try or say they like something, nor should they be faulted for disliking something or deciding not to partake. To encourage youth to go into the activity with an open mind, provide them with the language to respectfully discuss their food preferences. For example, rather than saying “I hate it” or “This is gross!” encourage youth to say “No, thank you,” “This isn’t for me,” or simply “I don’t like it.” Also, introduce the concept of a “Try Bite” as a way to encourage youth participation. After you take your one Try Bite, you can choose to take more bites if you like it or say “no thanks” and be done with the taste test.

Action for Healthy Kids offers additional taste test tips at:

### **Host a Taste Test:**

<https://www.actionforhealthykids.org/activity/host-a-taste-test/>

### **Cooking Activities**

If time and resources allow, you can expand upon the tasting activities by hosting a cooking demonstration or allowing youth to prepare a recipe using your garden fresh harvest. A successful cooking activity requires careful planning and preparation. Choose a recipe that matches the skill and maturity level of your participants. Cooking activities will also vary greatly depending on the number of youth participating, the number of adults available to supervise and assist, and the space and supplies available. There are many online resources available to help you select recipes and conduct school-based cooking activities. Here are a few you may want to explore:

### **The School Garden Cookbook by Captain Planet Foundation:**

<https://captainplanetfoundation.org/programs/project-learning-garden/cooking-cart/cookbook/>

### **Chop Chop Family:**

<https://www.chopchopfamily.org/>

### **Cooking Matters:**

<https://cookingmatters.org/>

### **Take Harvest Home**

If food tasting and preparation during programming time is not possible, don’t despair. It is always nice to be able to compensate your hardworking gardeners with fresh produce to take home, where both young gardeners and their families can enjoy it. For maximum benefit, make sure to send home prepping instructions and recipes.

# APPENDIX E

## Hydroponics for Early Childhood Educators

Early childhood is a wonderful time to begin gardening with students. Engaging hands-on lessons provide opportunities to support academic learning while also fostering social and emotional growth. Gardens also provide a foundation for positive nutritional attitudes and an introduction to healthy foods and exercise.

At this age, teaching about plants focuses on the basics such as plant parts, needs and lifecycles. Although the lessons in the Exploring Hydroponics Guide focus on older students who have already been introduced to plant basics and are ready to explore more advanced topics, growing plants in a hydroponic garden can certainly also provide a tool for teaching primary plant education too. In fact, a hydroponic garden can potentially offer advantages over a traditional garden. The increased growth rate of plants grown hydroponically will allow you to observe plant growth from seed to flower/fruit in a shorter period of time. Additionally, the ability to garden indoors allows you to extend your growing season, a big plus in more northern climates where the growing season does not always match the school year calendar. A garden in the classroom can also provide increased opportunities for observation.

If you are working with young children, below is a list of resources that offer activities and lesson plans specifically written for early childhood educators that can help you integrate your hydroponic garden into the curriculum:

### **Gro More Good Learning Activities**

<https://scottsmiraclegro.com/responsibility/foundation/activities/>

A joint project of The Scotts Miracle-Gro Foundation and the Smithsonian Early Enrichment Center, this curriculum provides a wide variety of lesson ideas for each season targeting Tiny Gardeners (infants and toddlers) through Garden Guides (grades 1 to 3).

### **KidsGardening Activities**

<https://kidsgardening.org/ece-garden-lessons/>

KidsGardening offers a wide variety of garden-related activity ideas that can be implemented at school or at home.



### **Rooted Farm to Early Care and Education:**

<https://www.rootedwi.org/for-educators/farm-early-care-education/>

A collection of resources, lessons and tips from Rooted in Wisconsin to help implement farm to early care education programs.

### **Growing Minds Farm to Preschool**

<https://growing-minds.org/farm-to-preschool/>

Growing Minds Farm to Preschool Program shares an extensive collection of lesson plans, a farm to school preschool kit and weekly resources designed for parents and families.

### **Grow It, Try It, Like It!**

<https://www.fns.usda.gov/tn/grow-it>

Grow It, Try It, Like It! is a garden-based nutrition education kit developed by the USDA for early childhood educators.

### **Life Lab: Sowing the Seeds of Wonder (Book)**

<https://www.gardeners.com/buy/sowing-the-seeds-of-wonder/8593687.html>

Sowing the Seeds of Wonder contains an extensive collection of tried and true ECE lesson plans from Life Lab.

### **Garden Adventures (Book)**

<https://www.gardeners.com/buy/garden-adventures/8593680.html>

Garden Adventures by KidsGardening provides lessons for early childhood educators focused on teaching plant through garden activities.

# APPENDIX F

## Resources

### Hydroponic Videos

**Exploratorium Subzero Water Works in McMurdo Station on Ross Island, Antarctica:**

<https://www.exploratorium.edu/video/subzero-water-works>

**Exploratorium Polar Paradise:**

<https://www.exploratorium.edu/video/polar-paradise?autoplay=true>

**Australian Antarctic Division: Hydroponics:**

<http://www.antarctica.gov.au/living-and-working/station-life-and-activities/food/hydroponics>

**Science and More: Scientists in Antarctica have harvested the first crop of vegetables grown without soil or light:**

<https://www.youtube.com/watch?v=MSJF5t0xX6Y>

**San Diego Hydroponic Farm from CaBountiful (6:40 minutes)**

<https://www.youtube.com/watch?v=zod-246VCkg&t>

**Hydroponic Spinach: How Does it Grow from True Food TV**

<https://www.youtube.com/watch?v=tG9bV2enwI0>

**Farm to School - San Diego Unified School District Harvest of the Month - Organic Bloomsdale Spinach (2:47 minutes)**

[https://www.youtube.com/watch?v=dA6NW\\_s6XKc](https://www.youtube.com/watch?v=dA6NW_s6XKc)

**CBS This Morning: How Aerofarms' vertical farms grow produce (5:10 minutes)**

[https://www.youtube.com/watch?v=ME\\_rprRImMM](https://www.youtube.com/watch?v=ME_rprRImMM)

**Vertical Roots Farm: Gardening in Repurposed Shipping Containers (8:01 minutes)**

<https://www.youtube.com/watch?v=jKY6OOrcwic>

**PBS News Hour: Could indoor farming help address food shortages? (9:36 minutes)**

<https://www.youtube.com/watch?v=7J9f59usLfl>

**State Fair of Texas – Big Text Urban Farm Tours:**

<https://bigtex.com/tour-the-big-tex-urban-farms/>

## **H-E-B: Eat The Rainbow with Bruce and Charlotte**

<https://www.youtube.com/watch?v=-iFrSKNyvfU>

## **Eat the Rainbow! Nutrition Lesson for Kids from The Physicians Committee**

<https://www.youtube.com/watch?v=L1StpMfMwXY>

## **FIT KIDS 23 Vitamins, Minerals, Nutrients Oh My from KSPS Public TV:**

[https://www.youtube.com/watch?v=0IKrRIbv\\_k&feature=emb\\_logo](https://www.youtube.com/watch?v=0IKrRIbv_k&feature=emb_logo)

## **Children's Books**

*Ready, Set, Grow!* Reading List of Multicultural Farm to Table Children's Books:

<http://www.pareadyssetgrow.org/book-list/>

*Growing Good Kids* – Excellence in Children's Literature Book Awards:

<https://jmgkids.us/bookawards/>

*Rainbow Stew* by Cathryn Falwell

*Can You Eat a Rainbow?* by Anastasia Suen

*The Rainbow Bunch* by Kia Robertson

## **Lesson Support**

### **Global Health: Hunger and Food Around the Globe:**

<https://www.learningtogive.org/units/global-health-hunger-and-food-around-globe-k-2>

### **The Life of a Tomato from Vermont FEED:**

<http://farmtoschool.tbaisd.org/wp-content/uploads/sites/9/2015/08/>

[LifeofaTomatoLesson.pdf](http://farmtoschool.tbaisd.org/wp-content/uploads/sites/9/2015/08/LifeofaTomatoLesson.pdf)

### **Little Lyrical Learners The Life Cycle of a Sunflower Seed Reader's Theater Play:**

<https://www.teacherspayteachers.com/Product/The-Life-Cycle-of-a-Seed-BUNDLE-Levelled-Scripts-and-Vocabulary-Cards-4617622>

### **How Far Does Food Travel to Get to Your Plate from the Center for Urban Education about Sustainable Agriculture:**

<https://cuesa.org/learn/how-far-does-your-food-travel-get-your-plate>

### **Photosynthesis Runs the World for a more extensive description of photosynthesis:**

<https://kidsgardening.org/lesson-plan-photosynthesis/>

## **Gardening Resources**

### **Hydroponics:**

<https://kidsgardening.org/garden-how-to-hydroponics/>

### **How to Start Seeds for Hydroponic Gardens:**

<https://kidsgardening.org/garden-how-to-starting-seeds-for-hydroponics/>

### **Indoor Seed Starting Q&A:**

<https://kidsgardening.org/gardening-basics-indoor-seed-starting-qa/>

### **Transplanting and Direct Seeding:**

<https://kidsgardening.org/gardening-basics-transplanting-and-direct-seeding/>

### **Starting a School Garden Program Overview at:**

<https://kidsgardening.org/create-sustain-a-program-starting-a-school-garden-program-overview/>

### **Gathering Support:**

<https://kidsgardening.org/create-sustain-a-program-gathering-support/>

### **Forming a Garden Committee:**

<https://kidsgardening.org/create-sustain-a-program-forming-a-garden-committee/>

### **Determining Garden Program Goals:**

<https://kidsgardening.org/create-sustain-a-program-determining-garden-program-goals/>

### **Funding a School Garden Program:**

<https://kidsgardening.org/create-sustain-a-program-funding-a-school-garden-program/>

### **Sustaining Your Garden Program:**

<https://kidsgardening.org/create-sustain-a-program-sustaining-your-program/>

### **People Resources – Valuing Volunteers:**

<https://kidsgardening.org/create-sustain-a-program-people-resources-valuing-volunteers/>